

CUADERNILLO DE ACTIVIDADES I
CUADERNILLOS PARA ACOMPAÑAR

ESTIMULACIÓN

COGNITIVA



Centro
PsicoSocial
Argentino

Nadia Rückauf

Autora

Prof. Daniel González

Prólogo y compilación

Cuadernillo I

Estimulación Cognitiva

© Nadia Rückauf

© Ed. Centro PsicoSocial Argentino, Buenos Aires, Argentina, Diciembre 2022

Derechos Reservados a la autora y Centro PsicoSocial Argentino. Queda prohibida su venta, distribución y/o difusión gráfica y/o digital, total o parcial, sin expresa autorización de la Autora.

Para citar: Rückauf, N. (2022) *"Cuadernillo I- Estimulación Cognitiva"*. Buenos Aires, Argentina. Ed. Centro PsicoSocial Argentino,

Índice

Introducción	3
Prólogo	4
¡A conocernos!.....	5
¿Dónde guardamos los siguientes objetos?	6
Lectoescritura.....	15
Vocales	15
Encerrar lo que comience con la letra.....	18
Abecedario.....	21
Actividades con números	51
Números del 1 al 10	51
Rompecabezas con dificultad matemática	57
Unir los puntos según la secuencia de números de menor a mayor.....	63
Actividades de Deducción	69
Descubrí al intruso.....	69
Marcar la combinación de colores correcta.	71
Secuencia.....	72
Laberintos.....	80
Encuentra las diferencias	82
Búsqueda de objetos.....	84
Grafo motricidad.....	89
Copiar el modelo	103
Continuar el modelo	109
Copiando más modelos	116
Espejo.....	121
Para pintar	129
Viso-construcción.....	143
Figuras geométricas.....	150
¡A jugar!.....	151
Búsqueda del tesoro	151
Bingo	154

Introducción

Este cuadernillo de actividades fue diseñado para trabajar con niños y niñas con distintas necesidades.

Las actividades están ordenadas por temática y dificultad para implementar según cada caso.

Espero que les guste y les sirva.

Muchas gracias por confiar en mí.

Nadia Rückauf

Acompañante Terapéutico



Prólogo

Prof. Daniel González- Psicólogo Social

La Importancia de Acompañar y seguir Aprendiendo Junt@s.

Una vez que obtenemos nuestro Cuadernillo, comienza el mundo del saber y la praxis, (teoría y práctica) juntas, lo que de cierta forma puede considerarse nutrir el saber, pero ningún día es igual al anterior. Hay algo intrínseco al trabajar con niños/as o Adultos. Cuyo resultado es que cada día puede ser un aprendizaje, es parte de la magia del ACOMPAÑAR.

Continuar aprendiendo sobre las y los niños/as y los Adultos que Acompañamos, sobre cómo atenderlas mejor, cómo compartir conocimientos con nuestros compañeros/as, conocer otras situaciones, cómo acompañar otras formas de entender la vida, la capacidad de ciertas personas adultas o niños/as a recomponerse en situaciones adversas y algunas relaciones que se forjan entre conversaciones apresuradas entre los Acompañados.

Este Cuadernillo es un Puente al Acompañado y su Familia. Gracias Nadia por compartir tu pasión y conocimientos.

Prof. Daniel González- Psicólogo Social

Presidente

Centro PsicoSocial Argentino

¡A conocernos!

Mi nombre es:

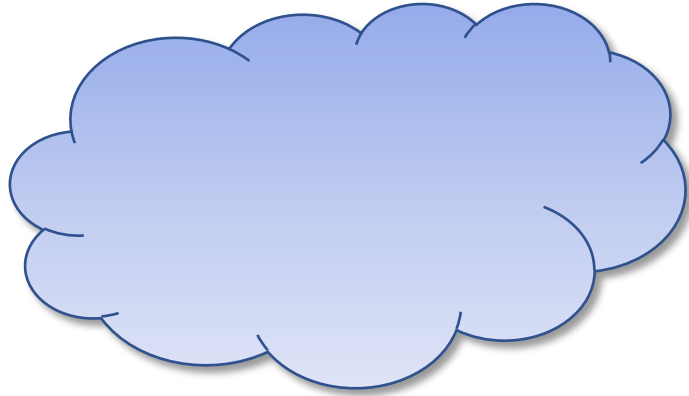

Tengo ____ años.

Dibuja o pega una foto tuya:

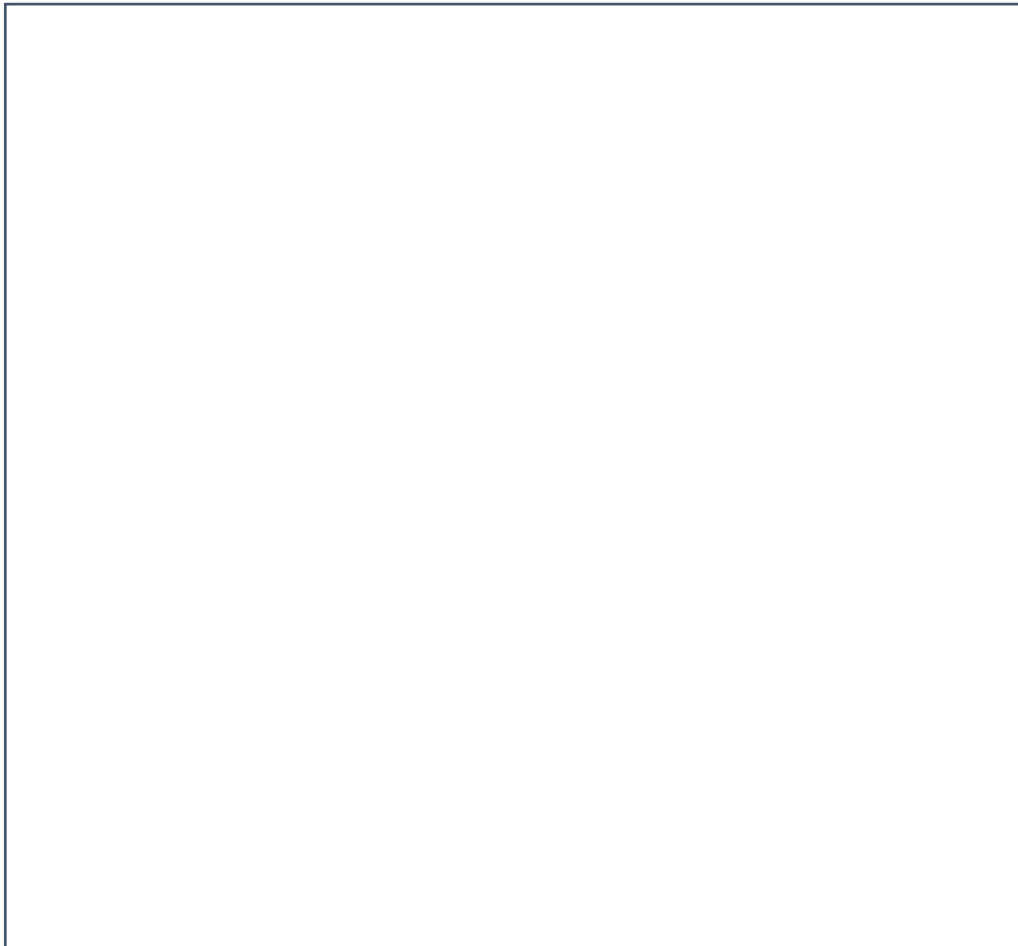

¿Dónde guardamos los siguientes objetos?



Escribirlos o dibujarlos en el recuadro que corresponda:

MOCHILA

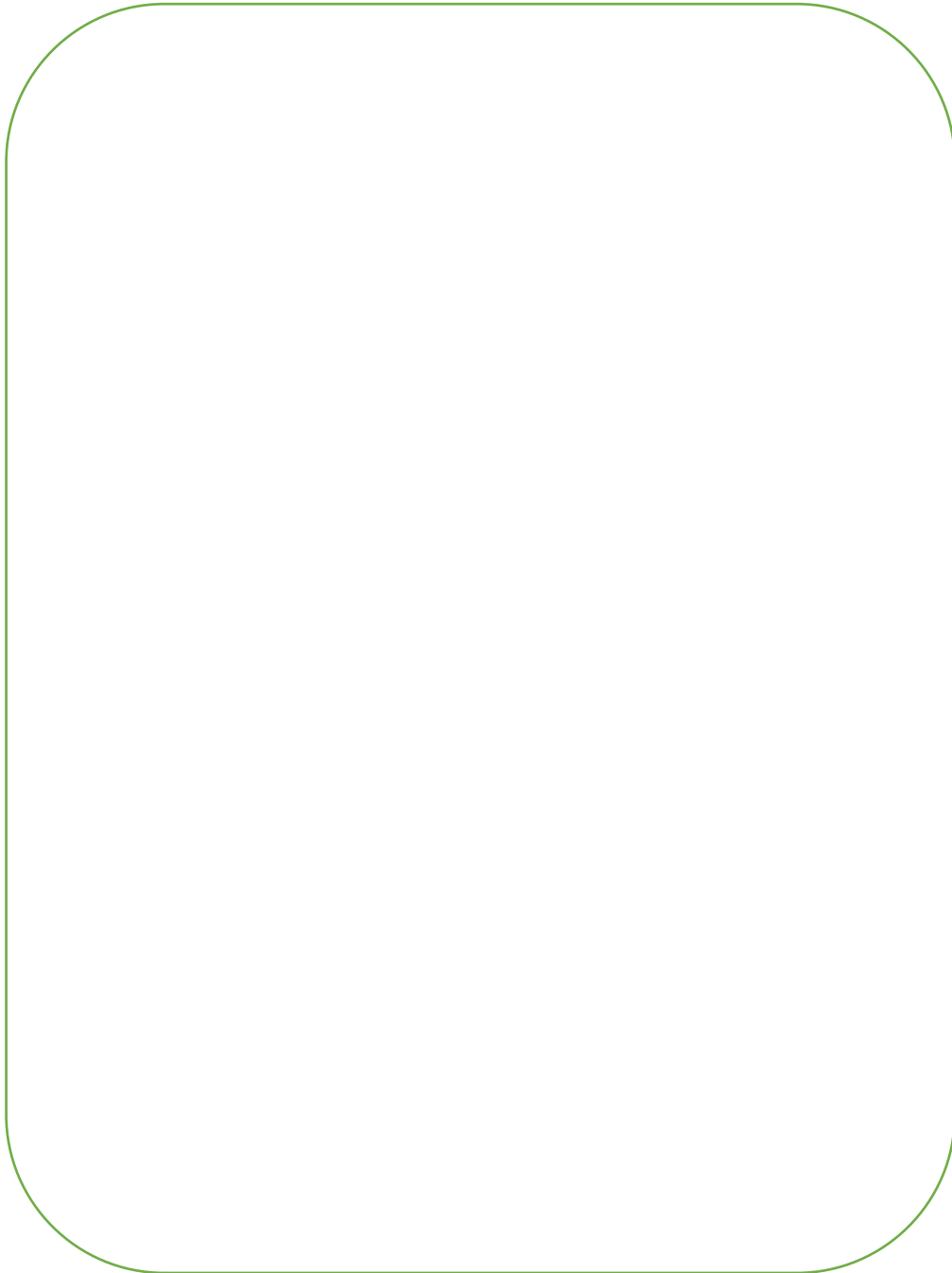

HELADERA

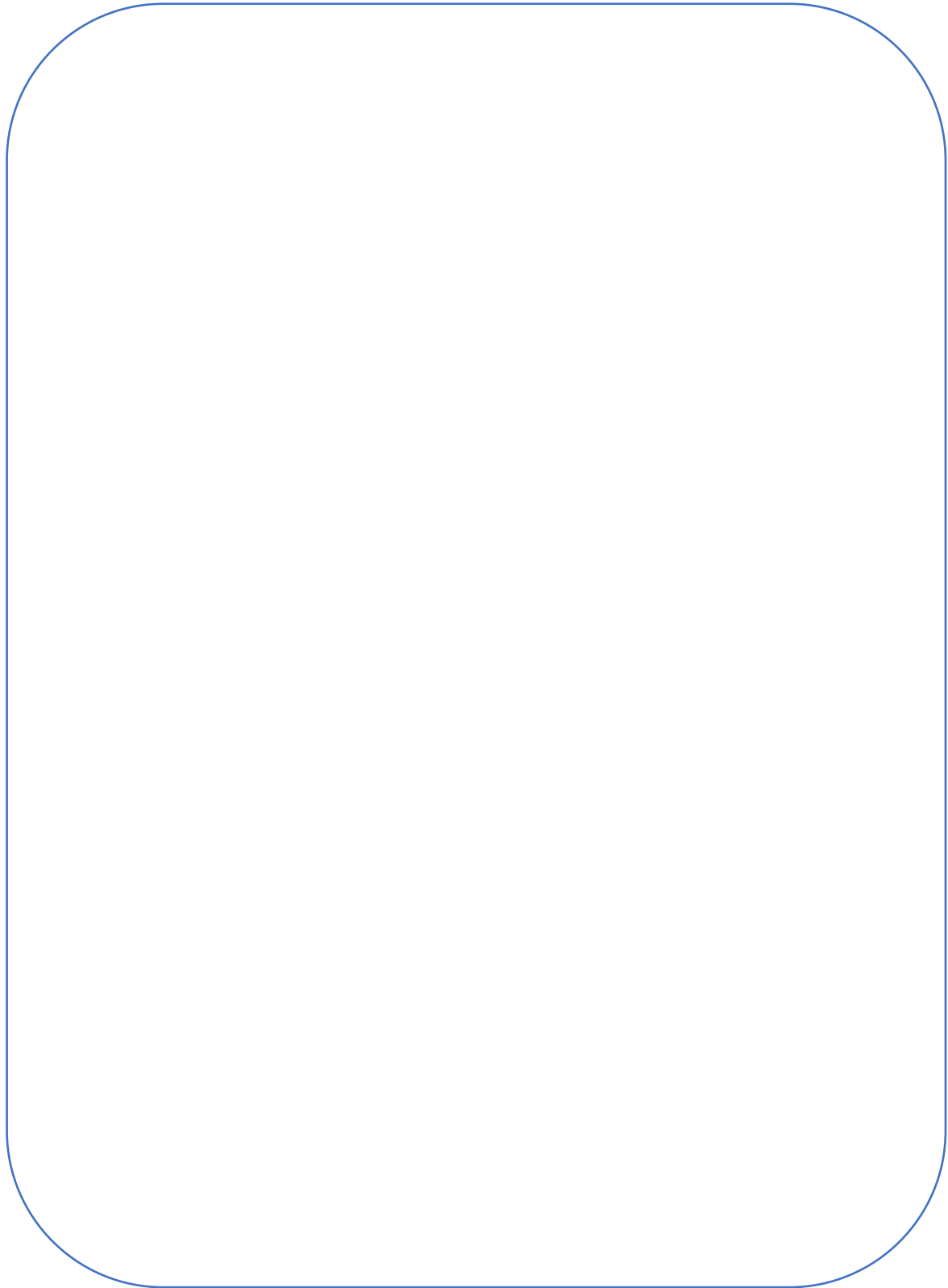

MUEBLE DE COCINA



PARA LA PLAYA



CAJA DE HERRAMIENTAS

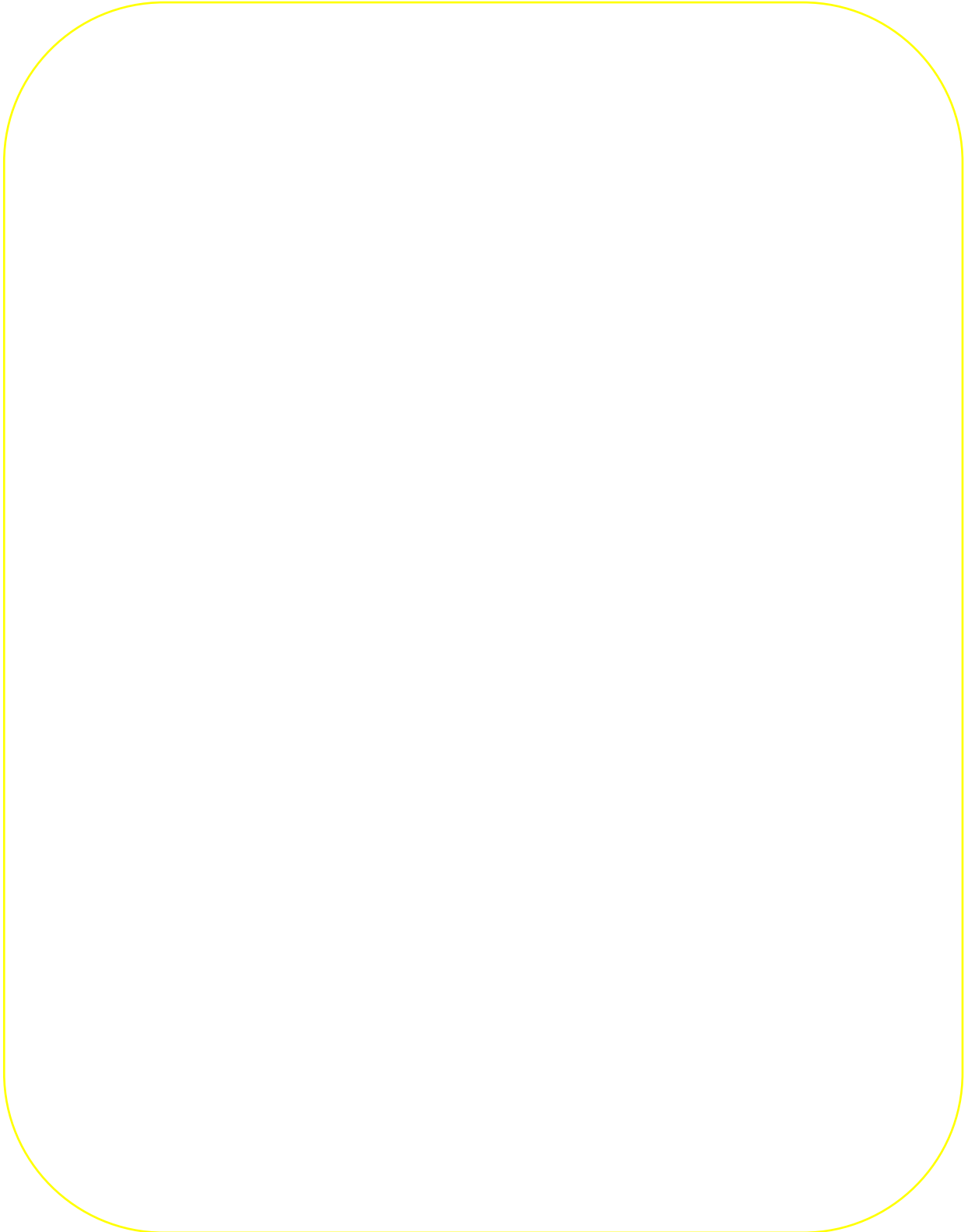

COSTURERO



CARTERA

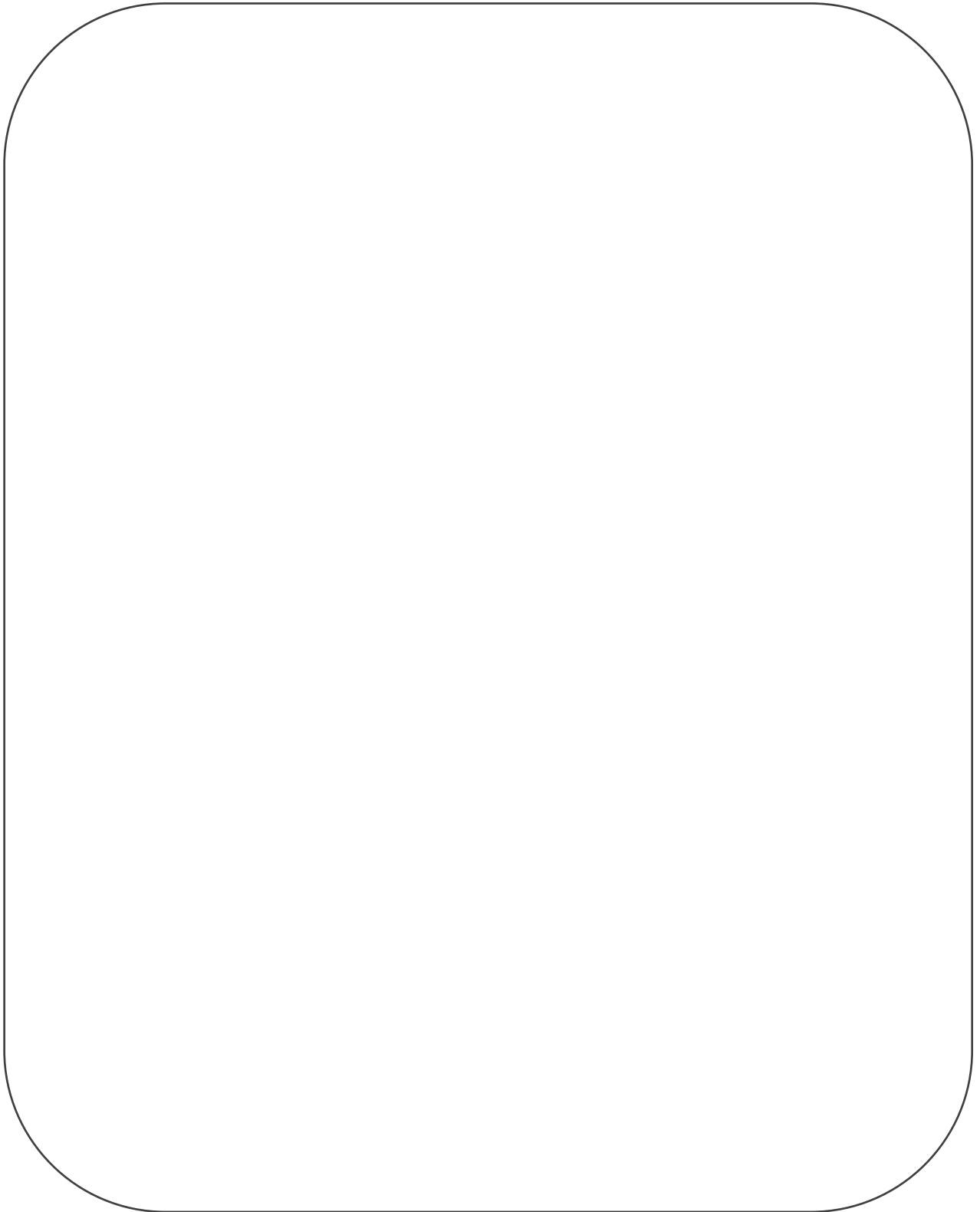

BOTIQUÍN



Lectoescritura

Vocales

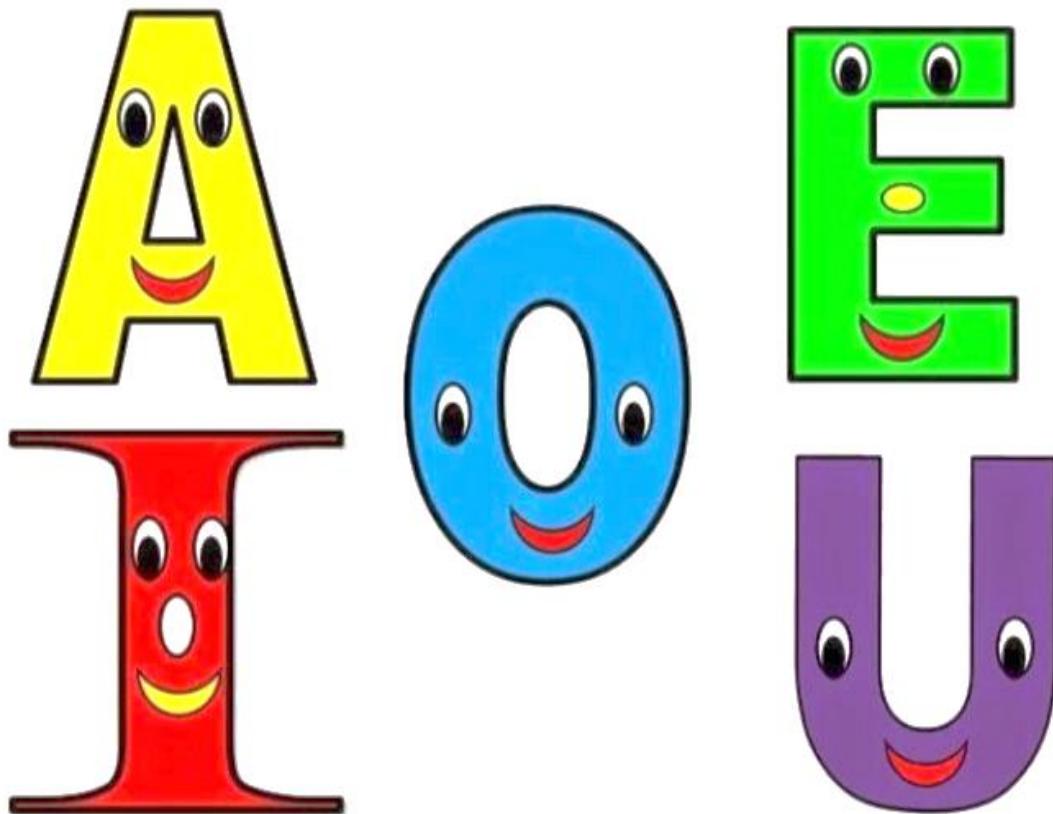

Actividad para unir con flecha según el sonido con la vocal que empieza cada imagen

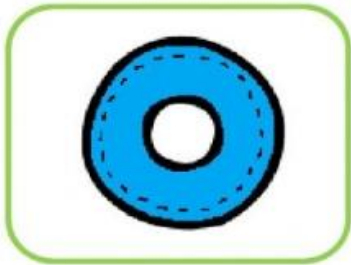
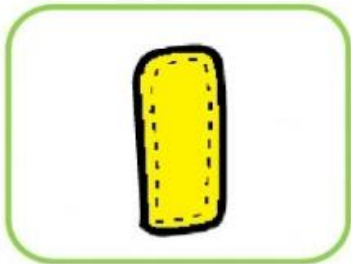

Separar en sílabas y luego formar la palabra

			_____
---	--	--	-------

			_____
---	--	--	-------

			_____
---	--	--	-------

			_____
---	--	--	-------

Colorear consonantes para formar la palabra

 **A** **A**

 **O** **A**

 **U** **E**

 **I** **E** **A**

 **I** **A** **A**

Encerrar lo que comience con la letra...

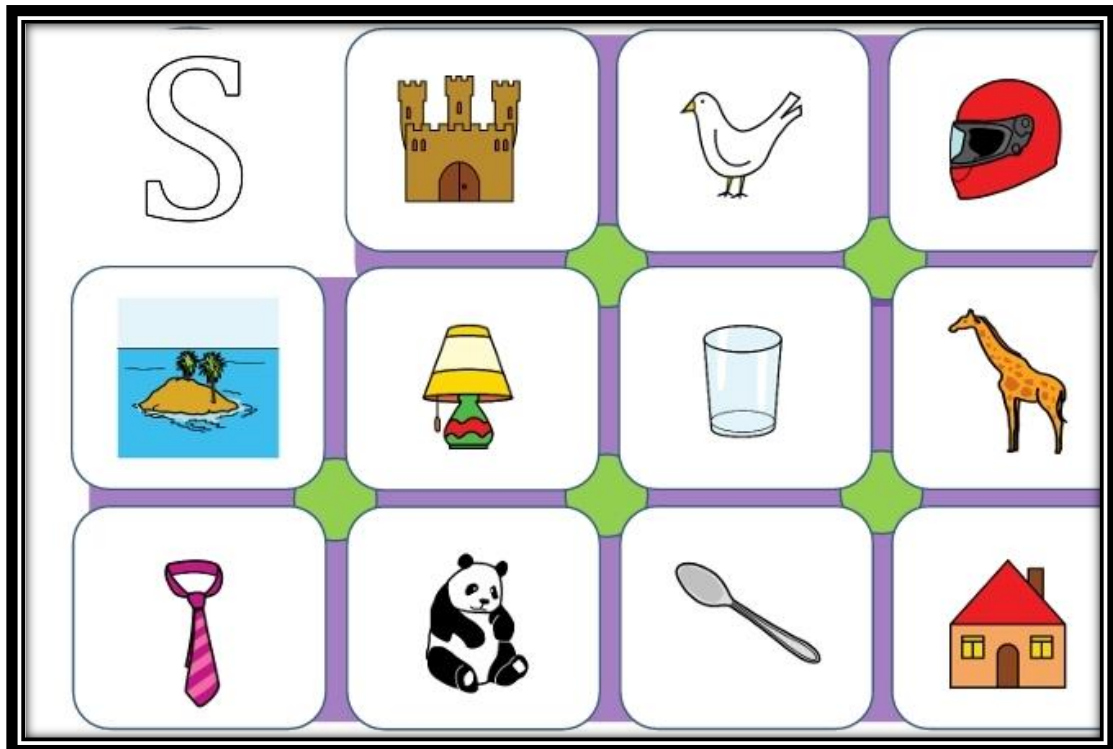
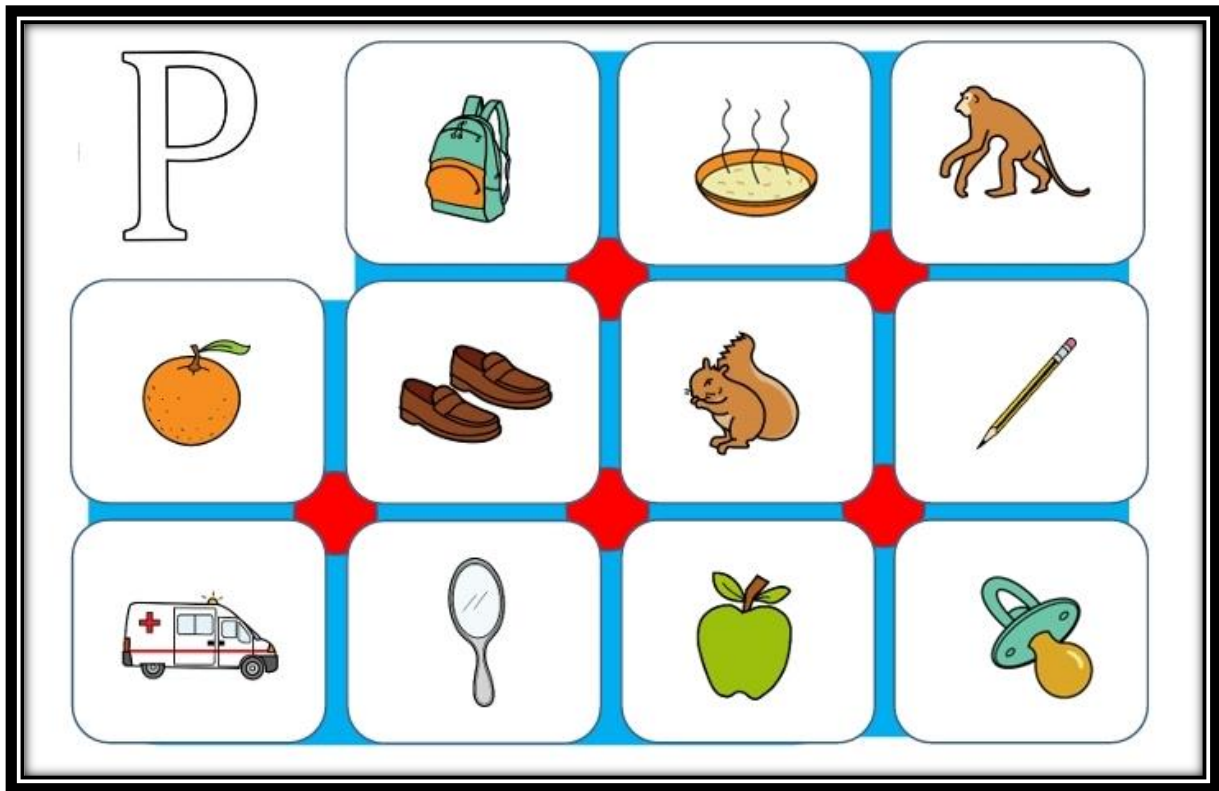

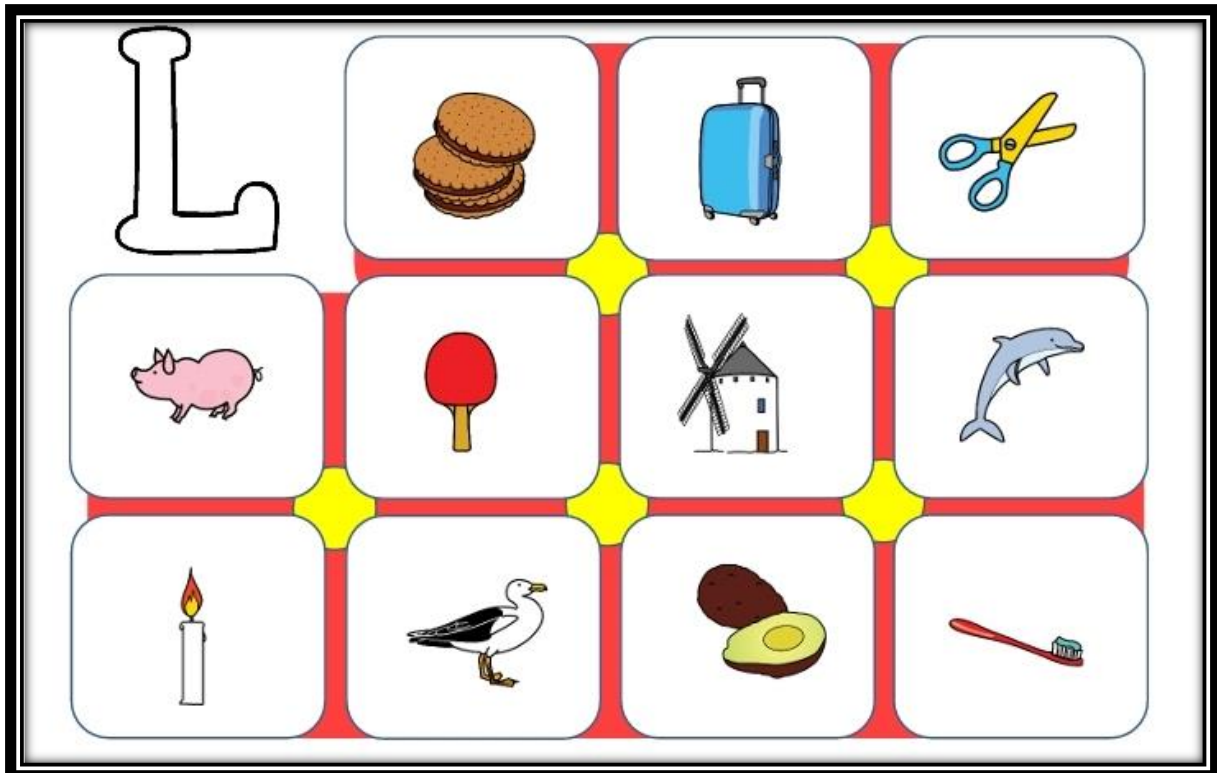
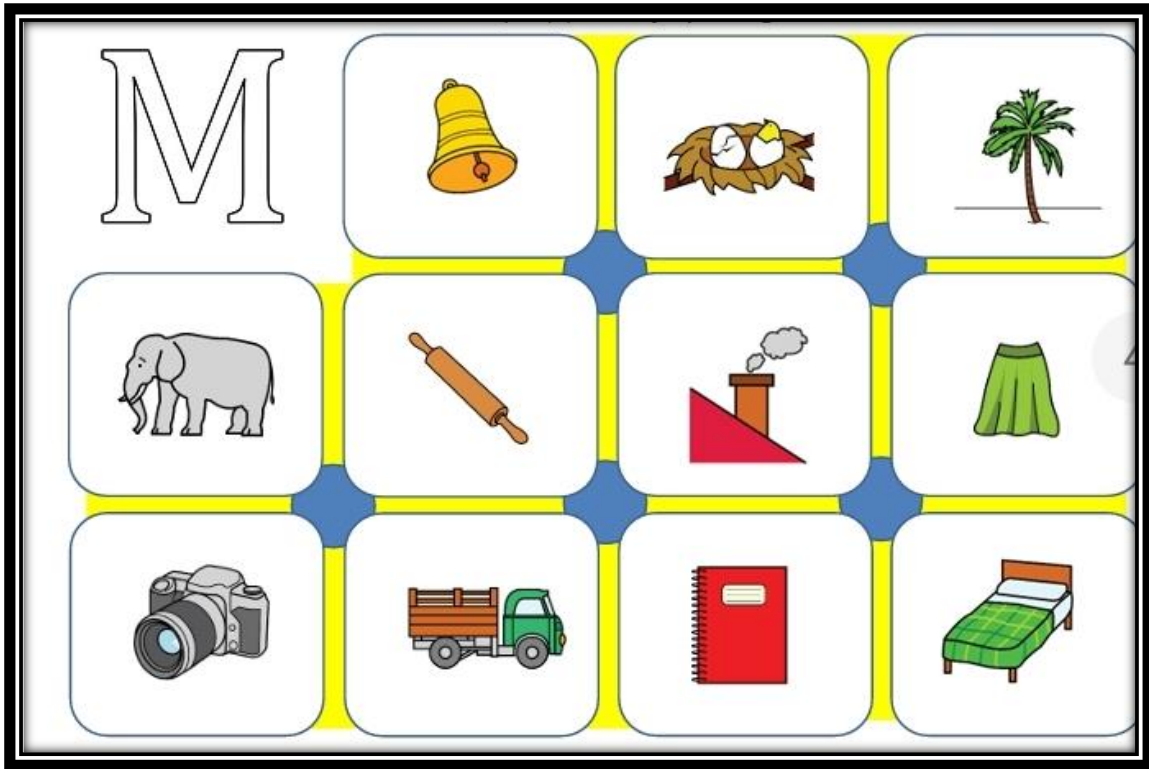

Abecedario

 AVIÓN A	 BARCO B	 CASA C	 DADO D	 ELEFANTE E
 FRUTILLA F	 GATO G	 HUEVO H	 IGLÚ I	 JIRAFÁ J
 KOALA K	 LEÓN L	 LLAVE LL	 MOTO M	 NIDO N
 ARAÑA Ñ	 OJO O	 PATO P	 QUESO Q	 RATÓN R
 SANDÍA S	 TREN T	 UVAS U	 VACA V	 WINDSURF W
 XILOFÓN X	 YOYO Y	 ZANAHORIA Z		



Ana

A a



Bob
Esponja

B **b**



**Capitán
América**

C C



Dora

D **d**



Chavo

CH ch



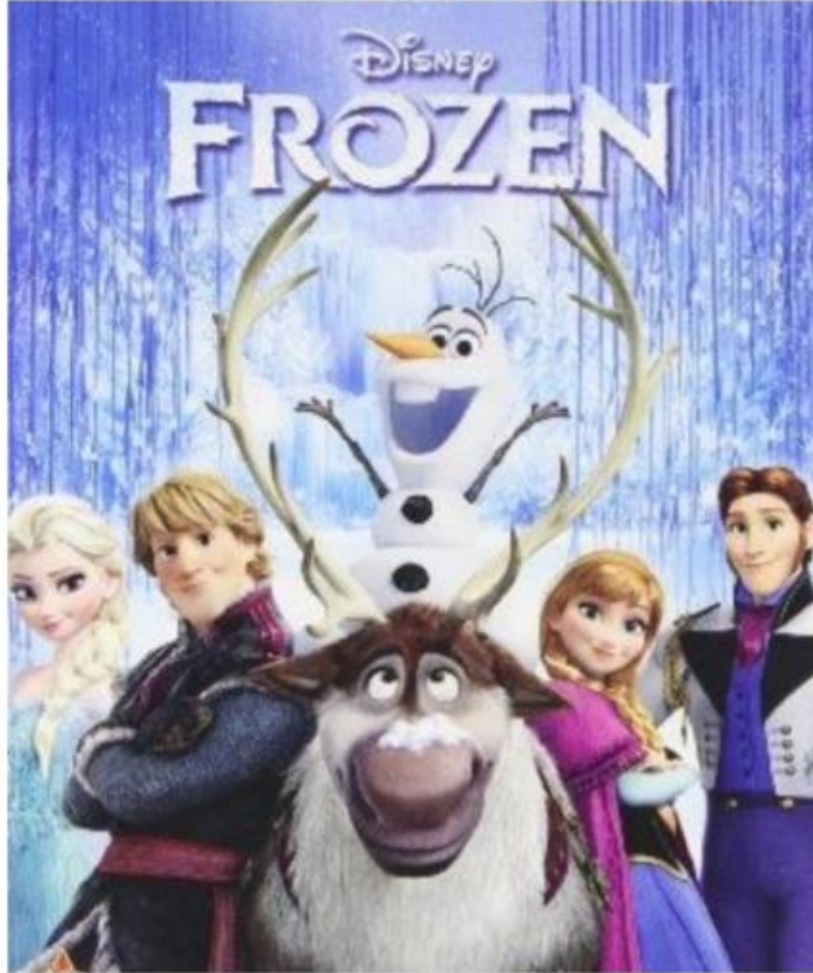

F **f**



Goku

Gg



Hulk

H h



Iron man





Jorge el curioso

J j



Kung fu Panda

K **k**



Linterna verde





Lluvia de hamburguesas





15/29

Mickey Mouse

M m



Naruto

N n



Ñoño

Ñ ñ



**Optimus
Prime**







Quico

Q **q**



Ralph , el demoledor

R r



Superman

S s



Tortugas Ninja

T

↑



Ultraman

U U



Valiente

V

v



Wolverine

W **w**



X-MEN

X X



Yoda

Y **y**



zootopia

Z z

Actividades con números

Números del 1 al 10

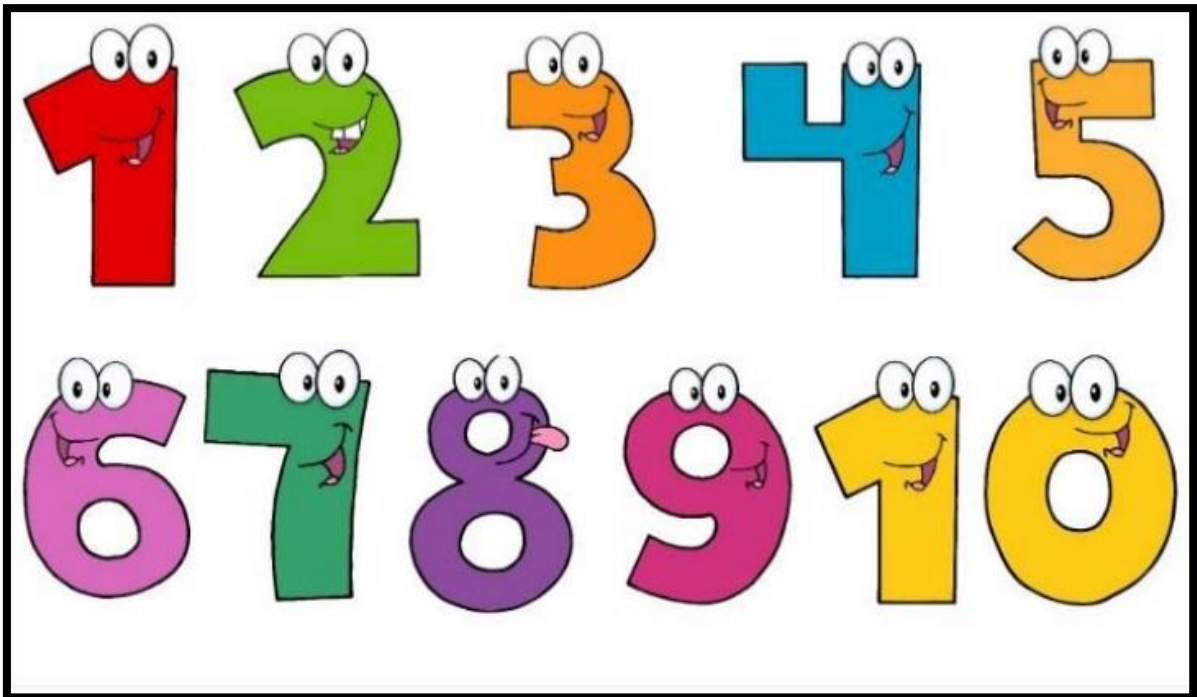

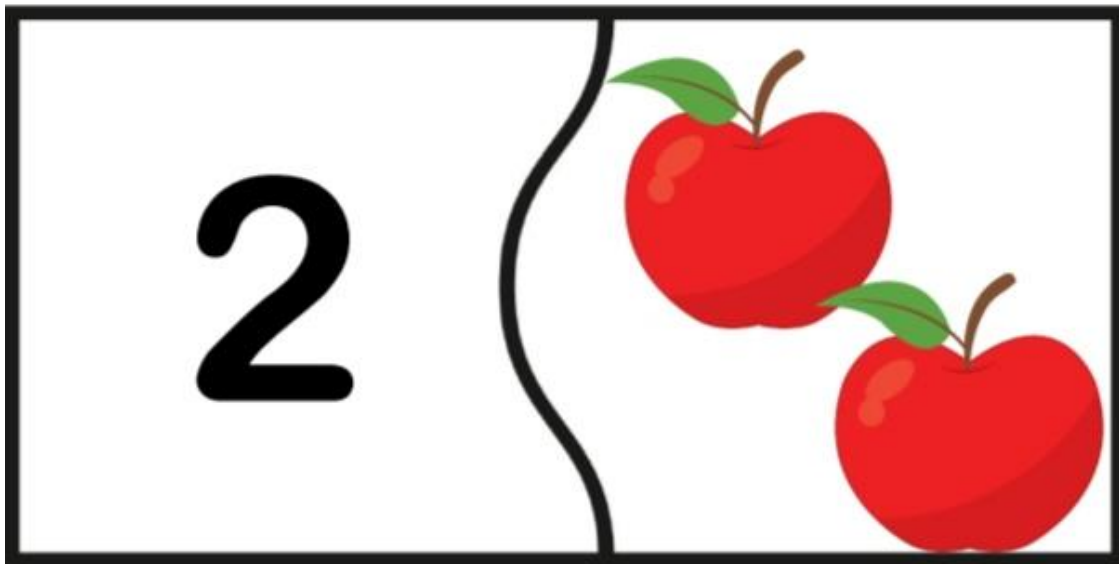
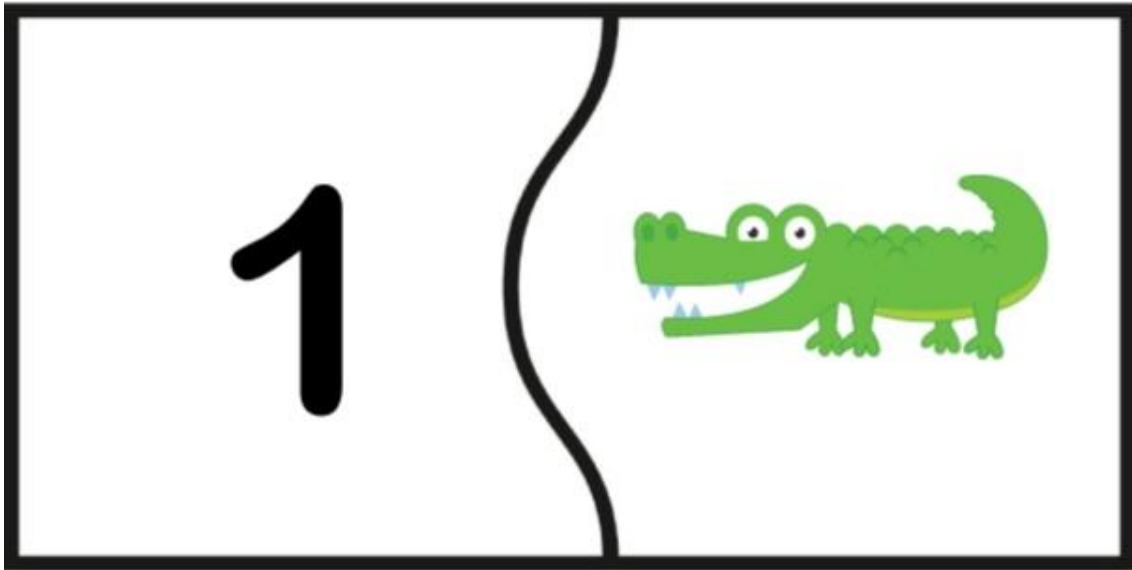

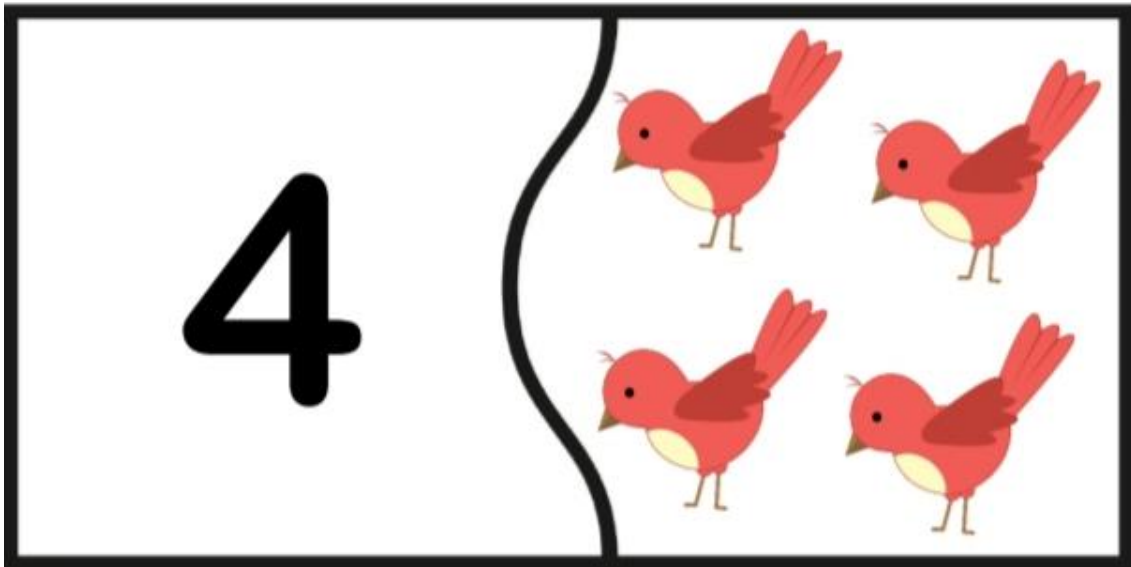
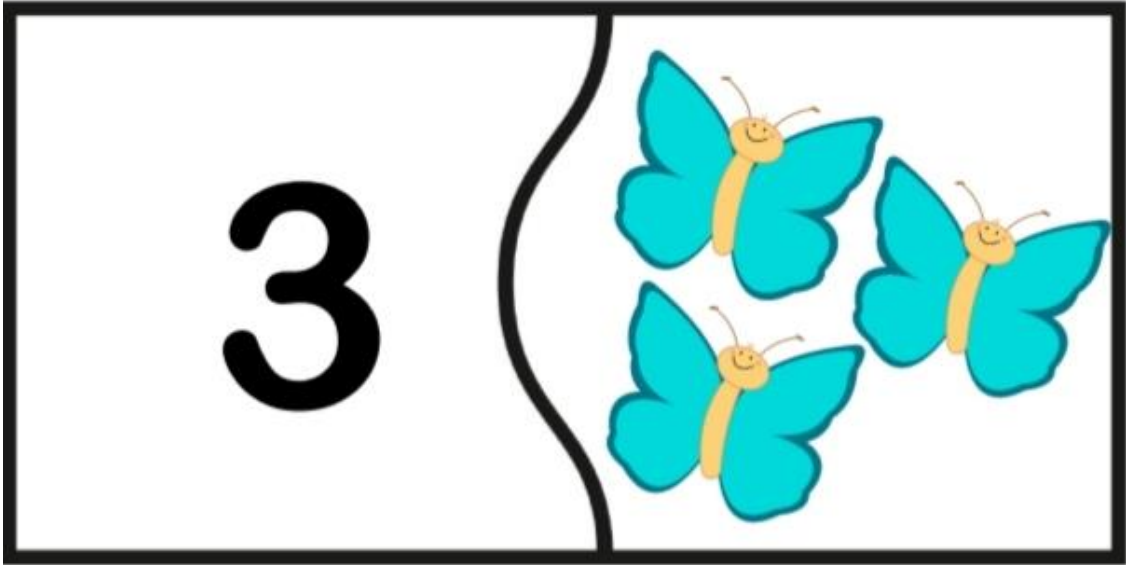



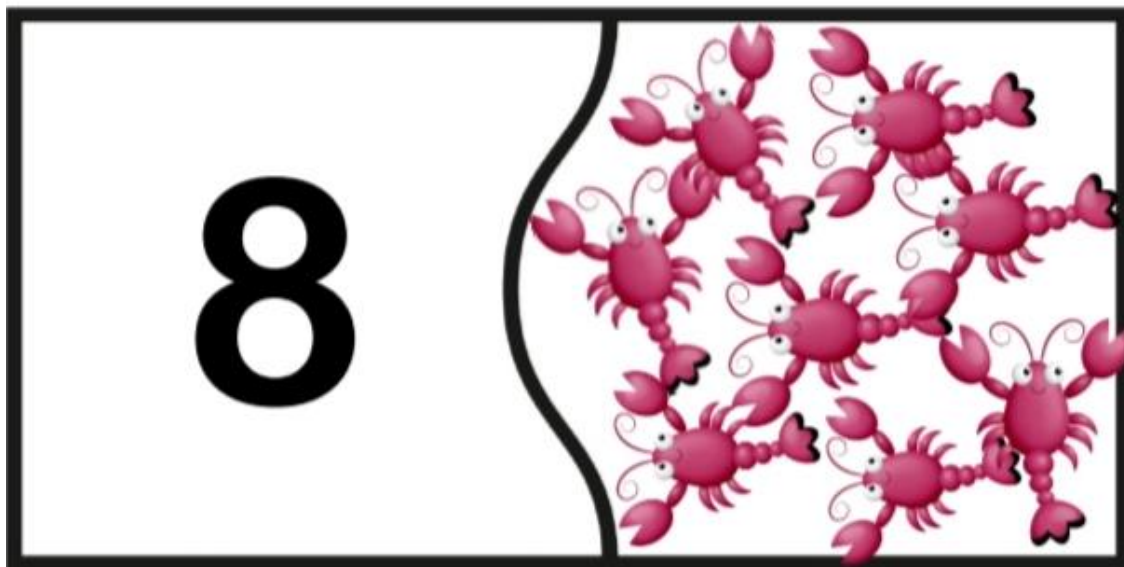

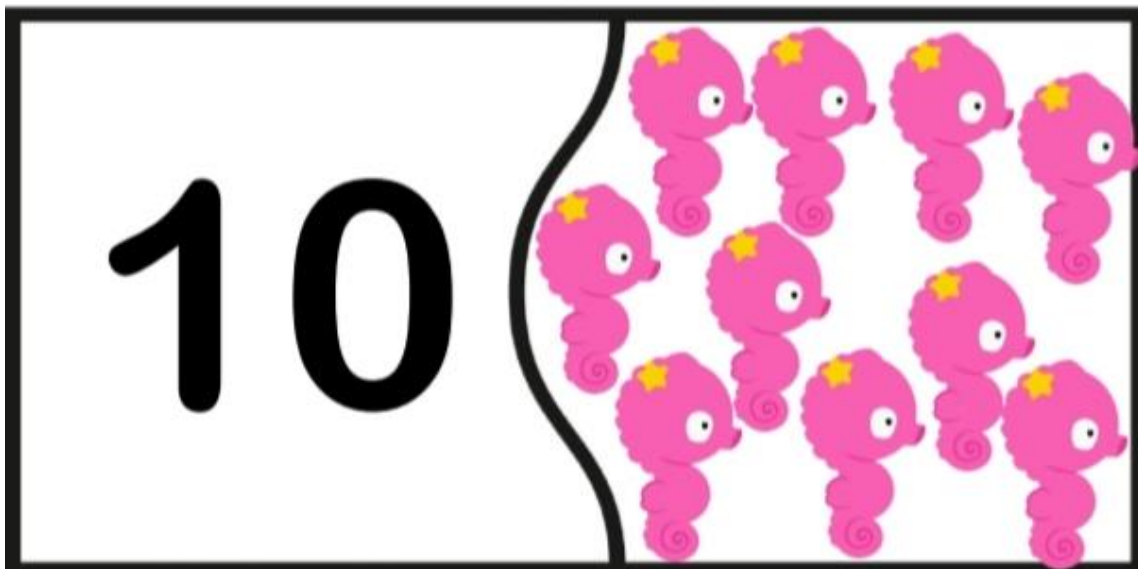
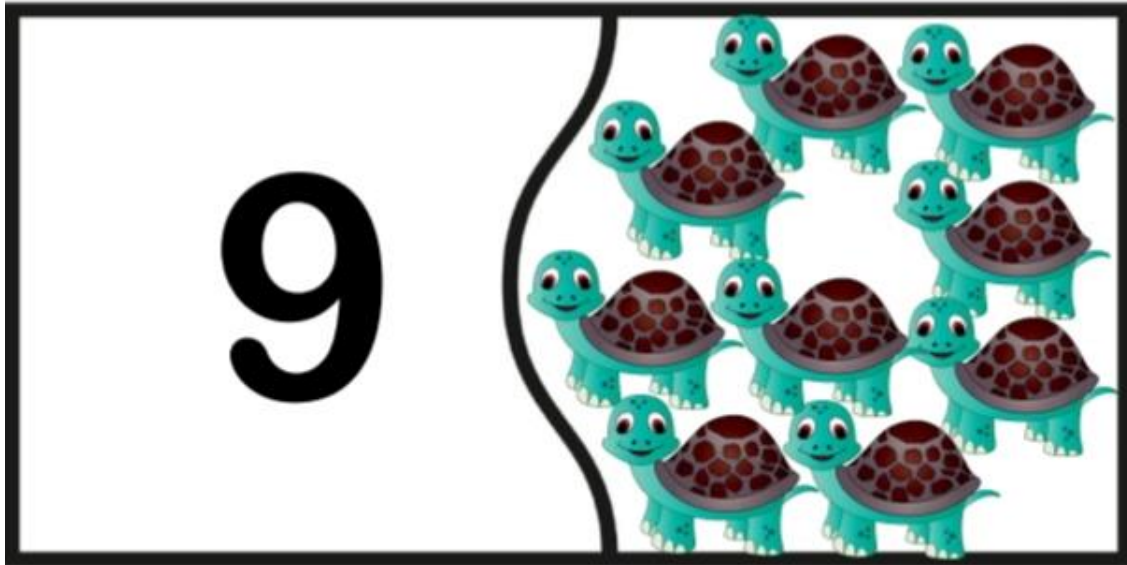

Rompecabezas con dificultad matemática

+	78	24	89	36
7				
26				
38				

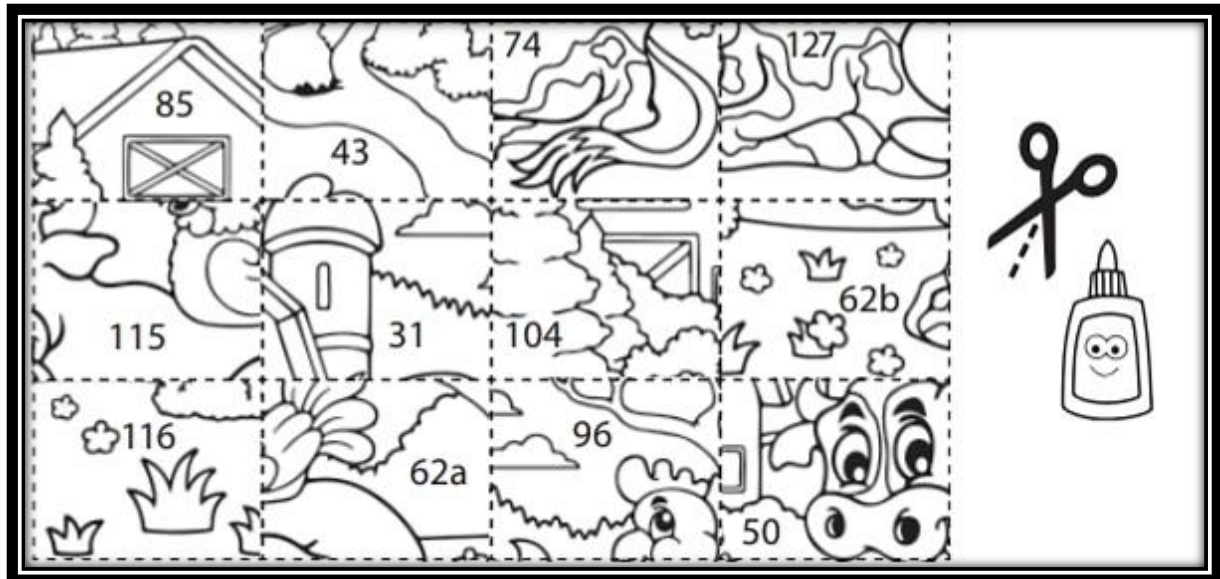

+	250	467	890	24
13				
99				
307				

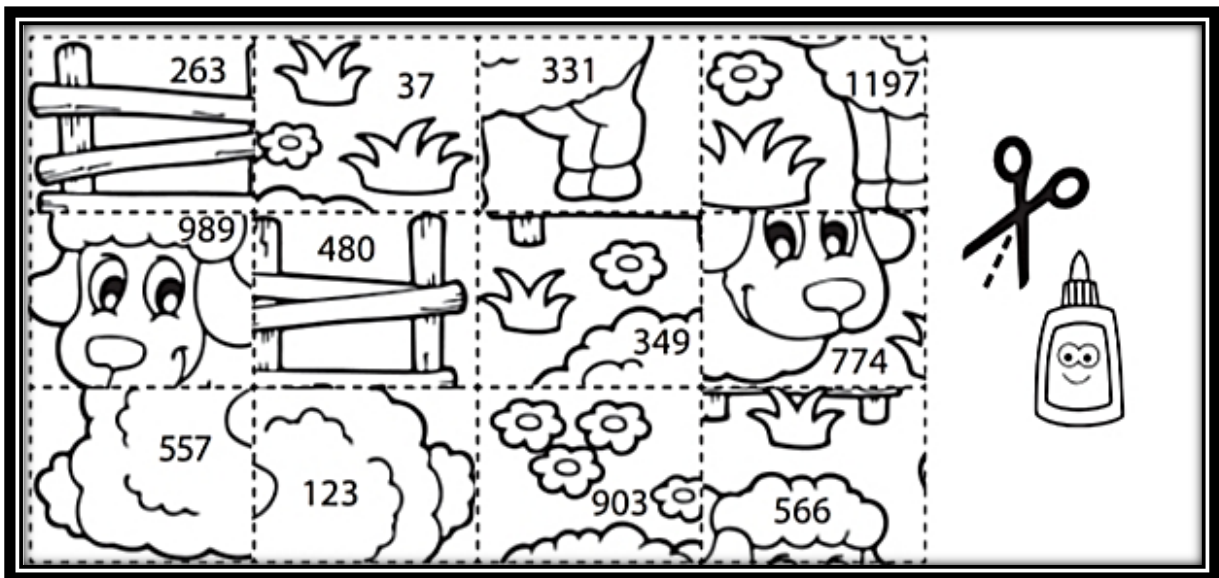

-	36	12	15	22
50				
66				
72				

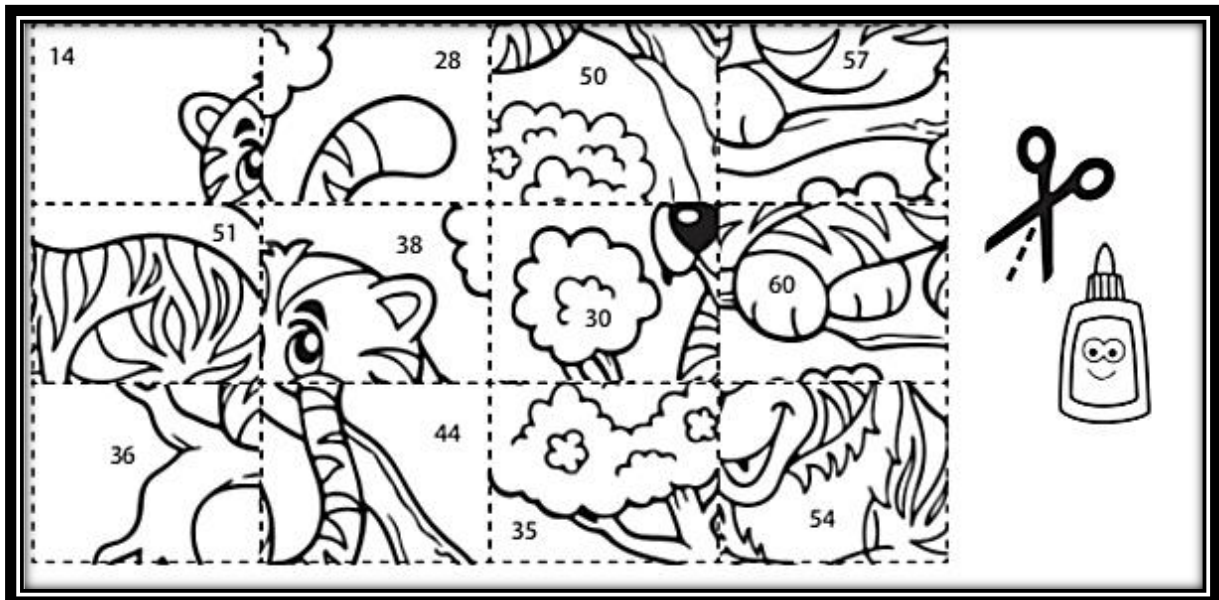

-	33	22	45	30
95				
48				
73				

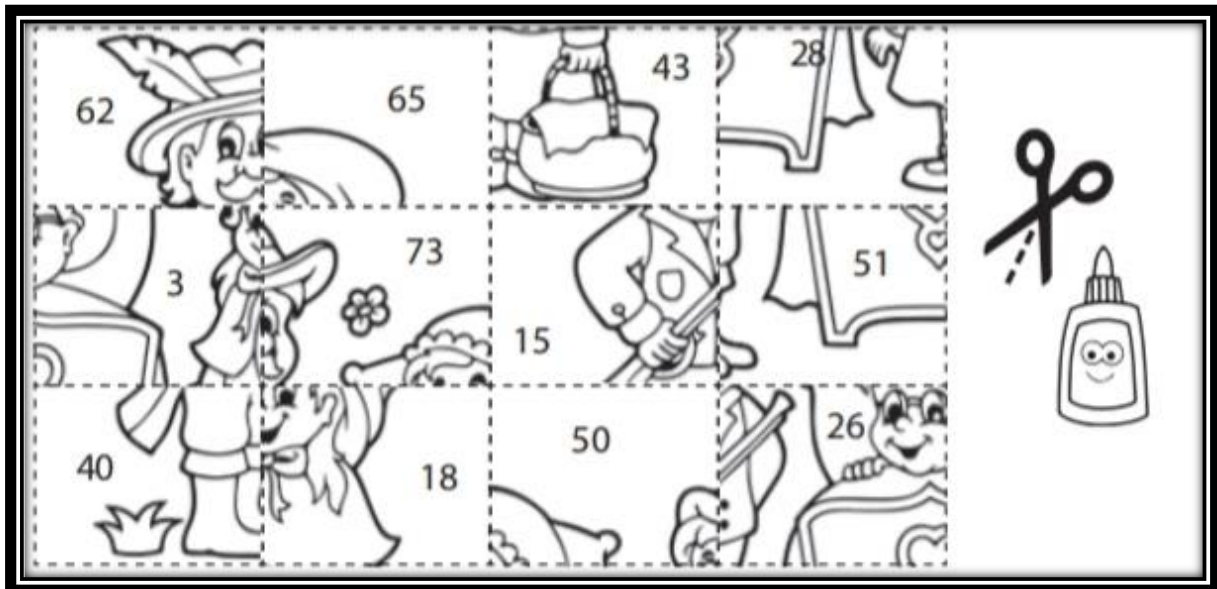

X	222	678	489	750
31				
67				
89				

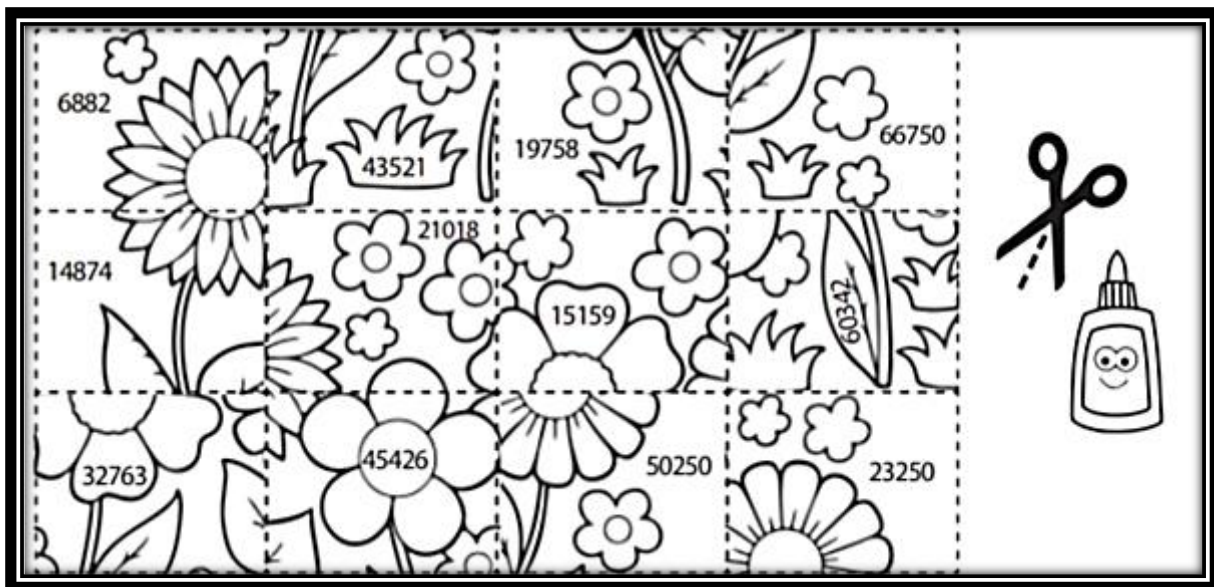

x	15	30	25	72
22				
47				
69				

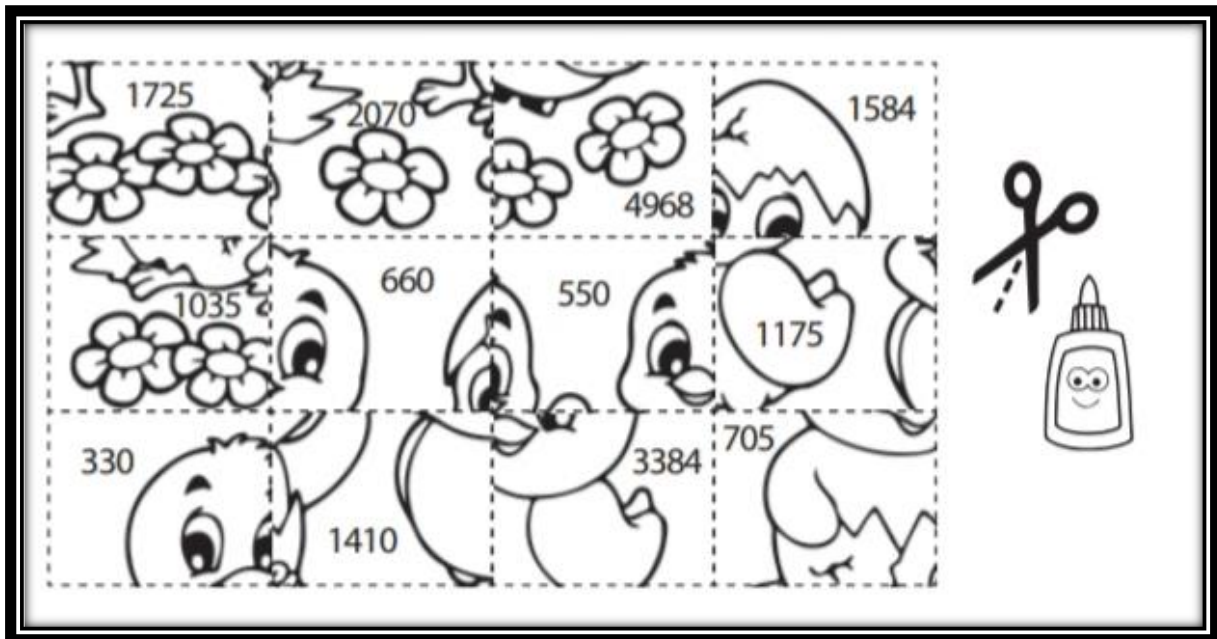

Unir los puntos según la secuencia de números de menor a mayor.

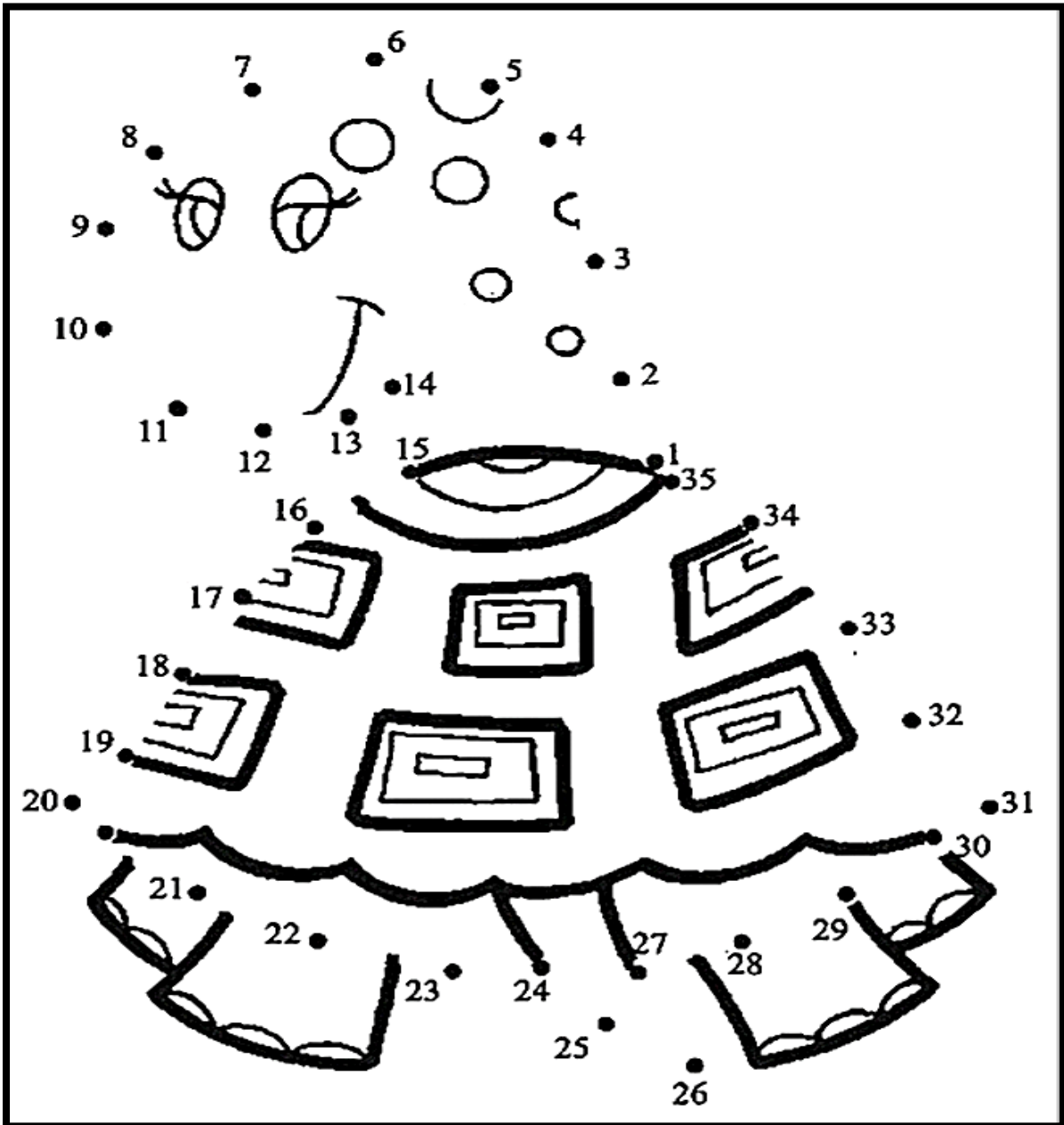

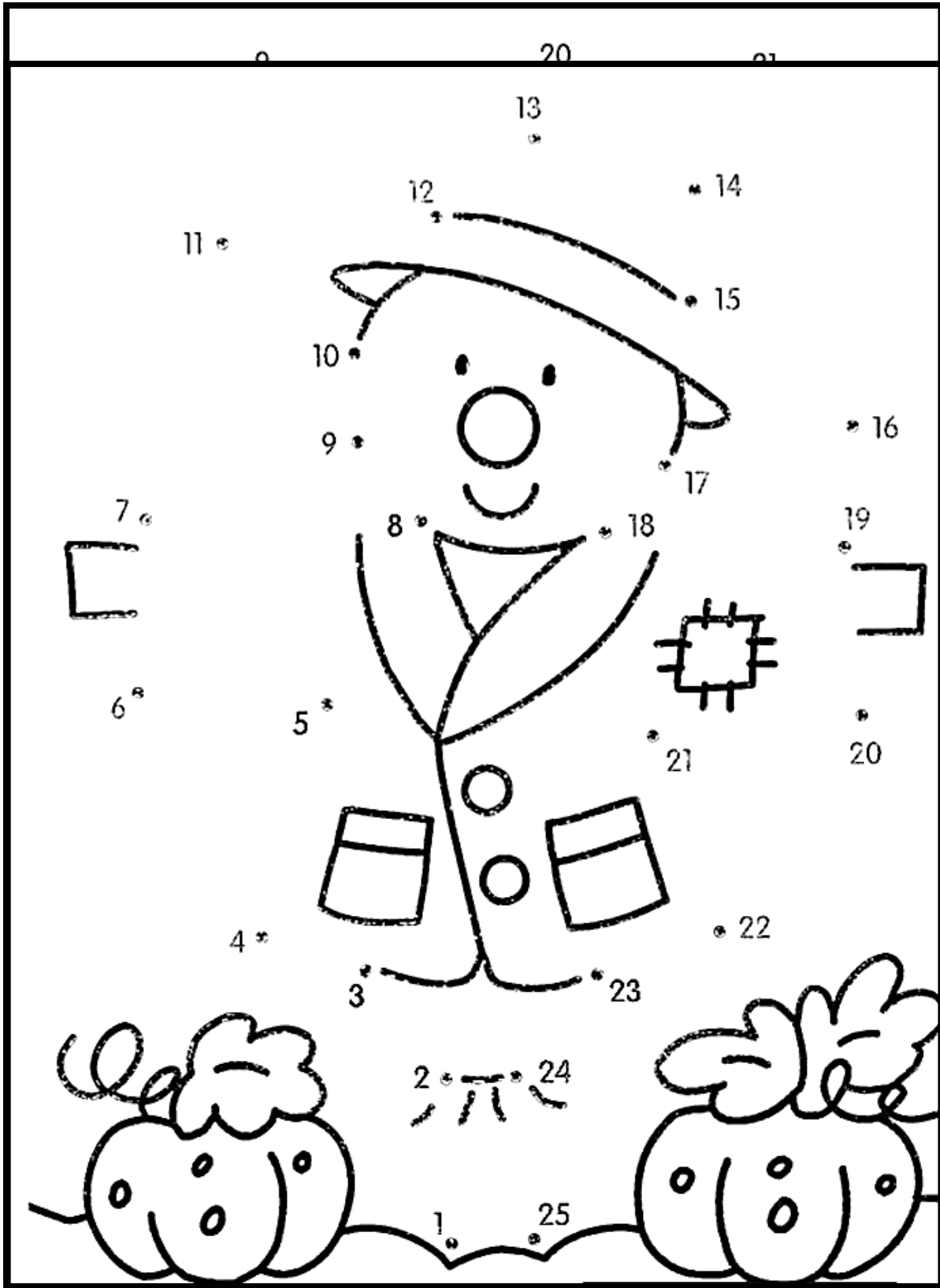

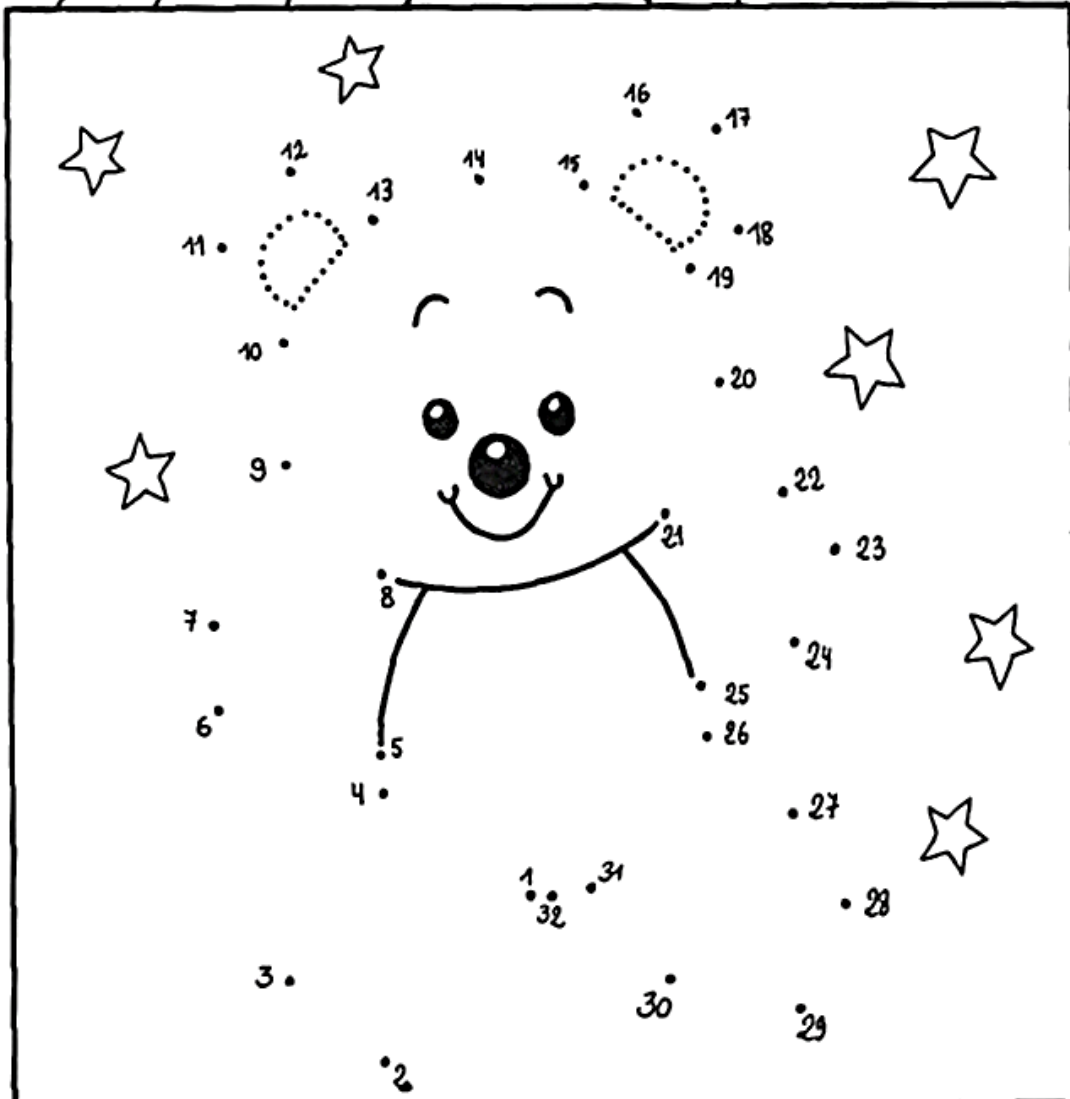

71

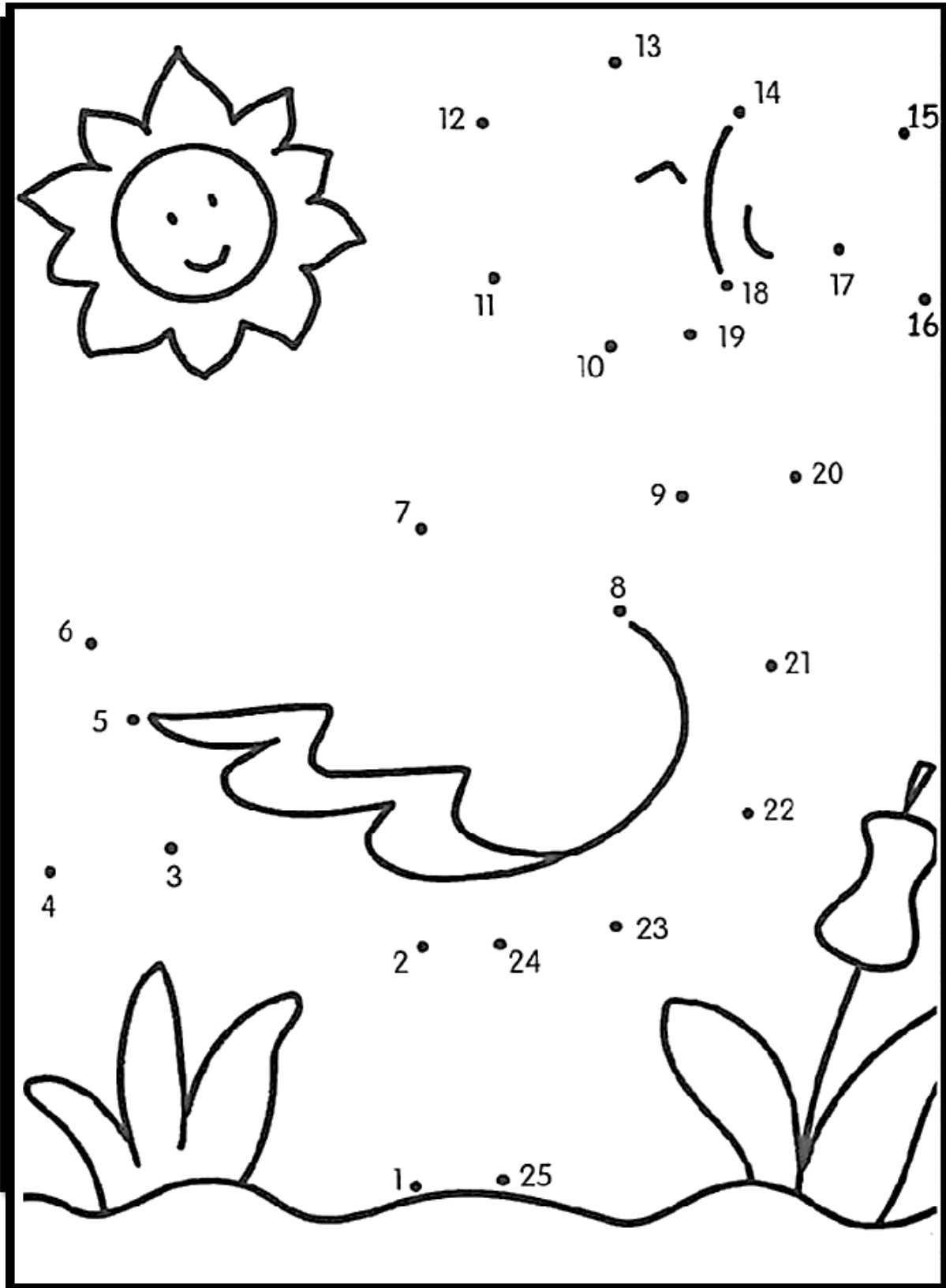

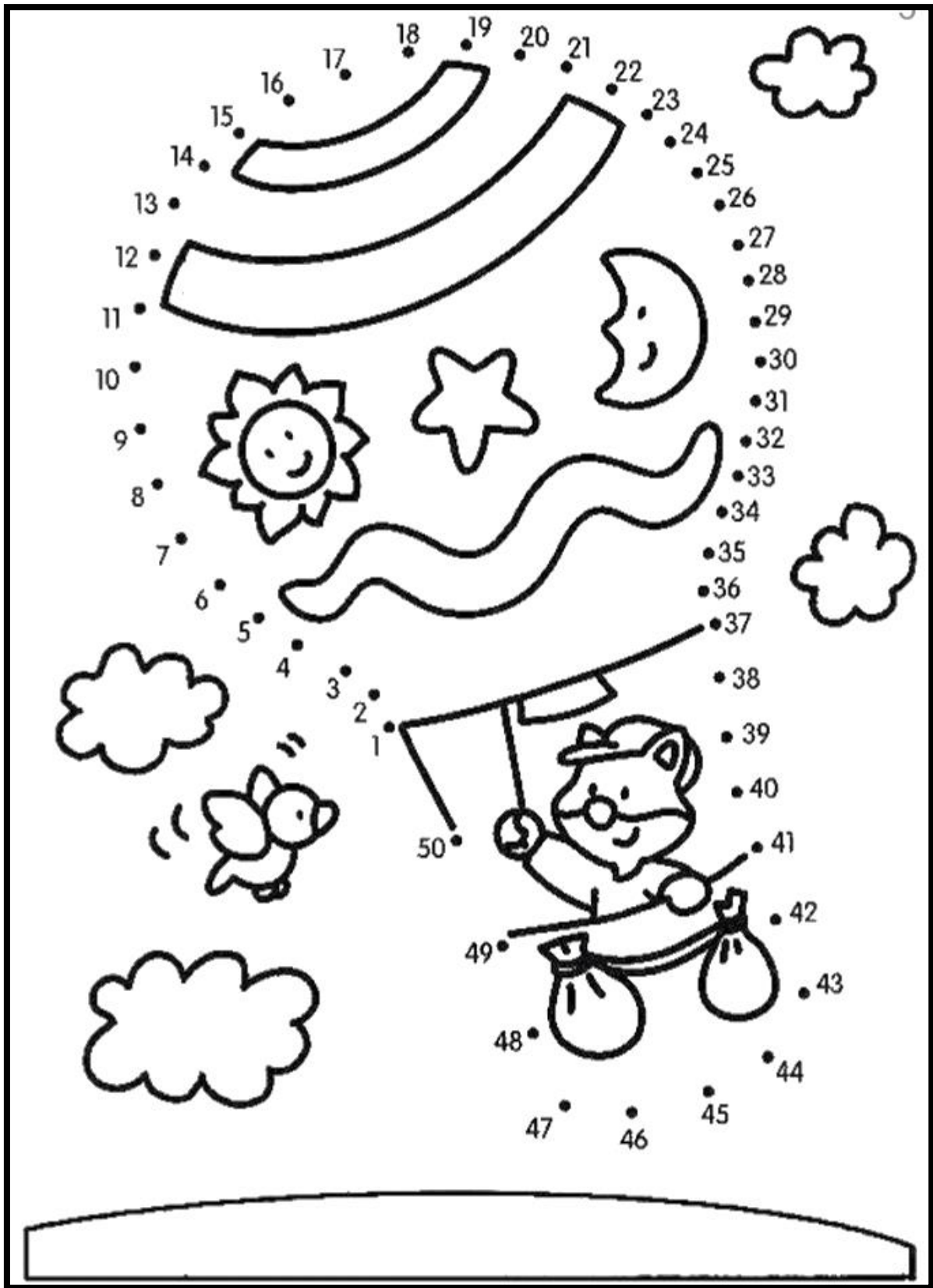

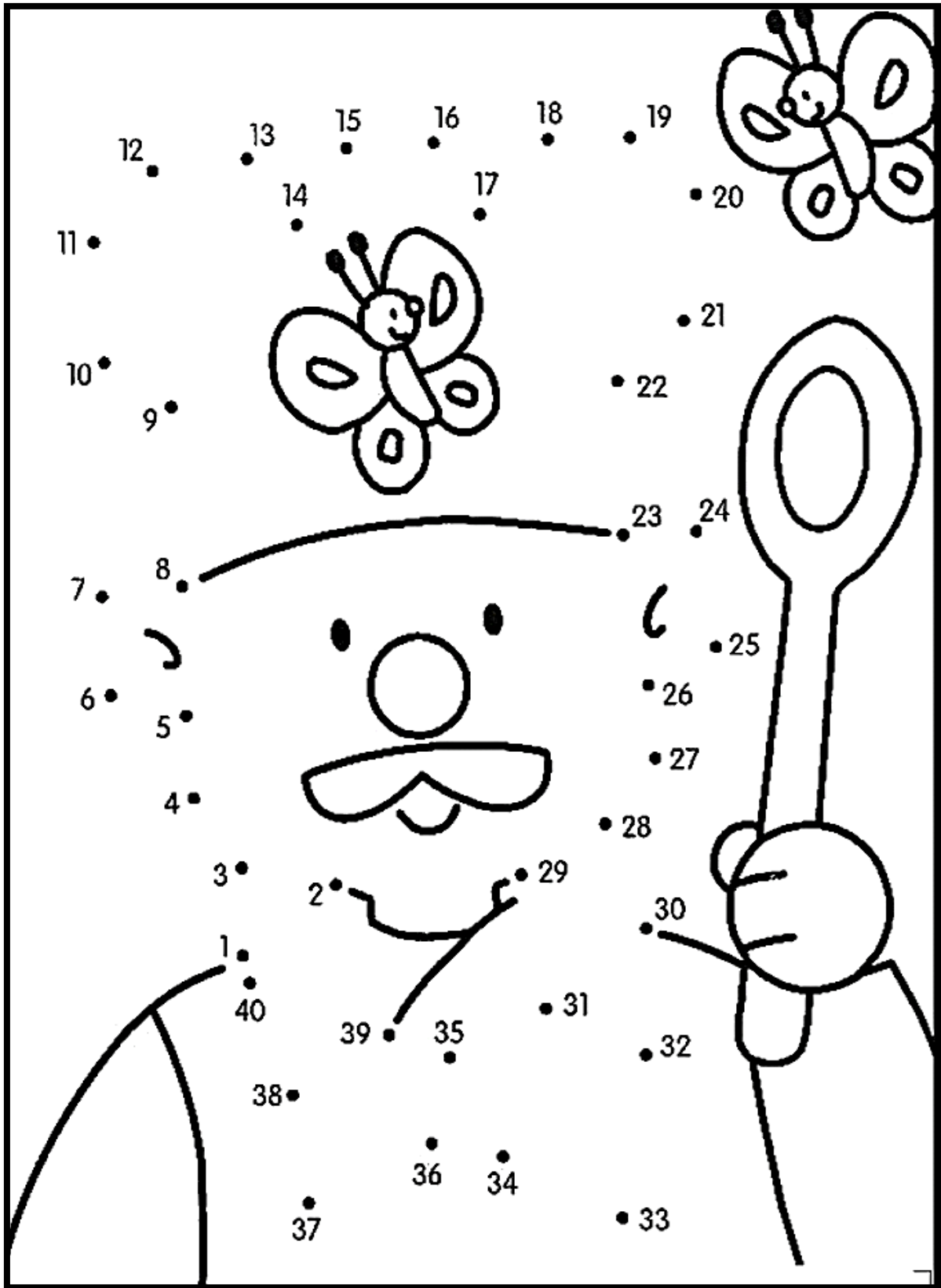

Actividades de Deducción

Descubrí al intruso





Marcar la combinación de colores correcta.

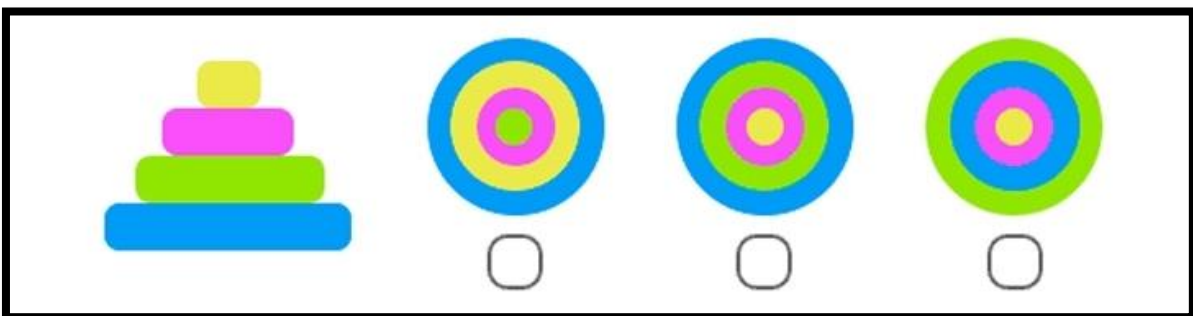
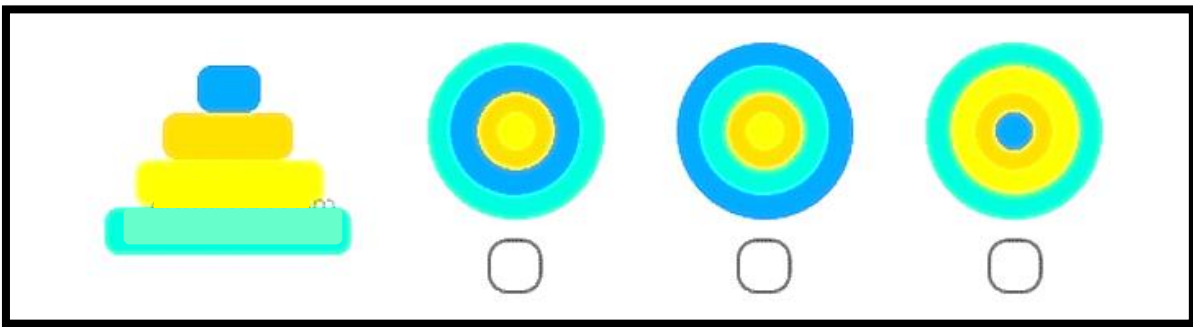
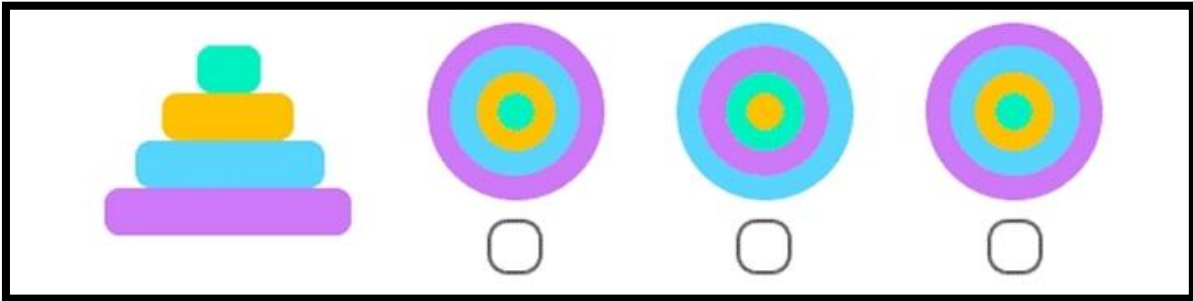

Secuencia

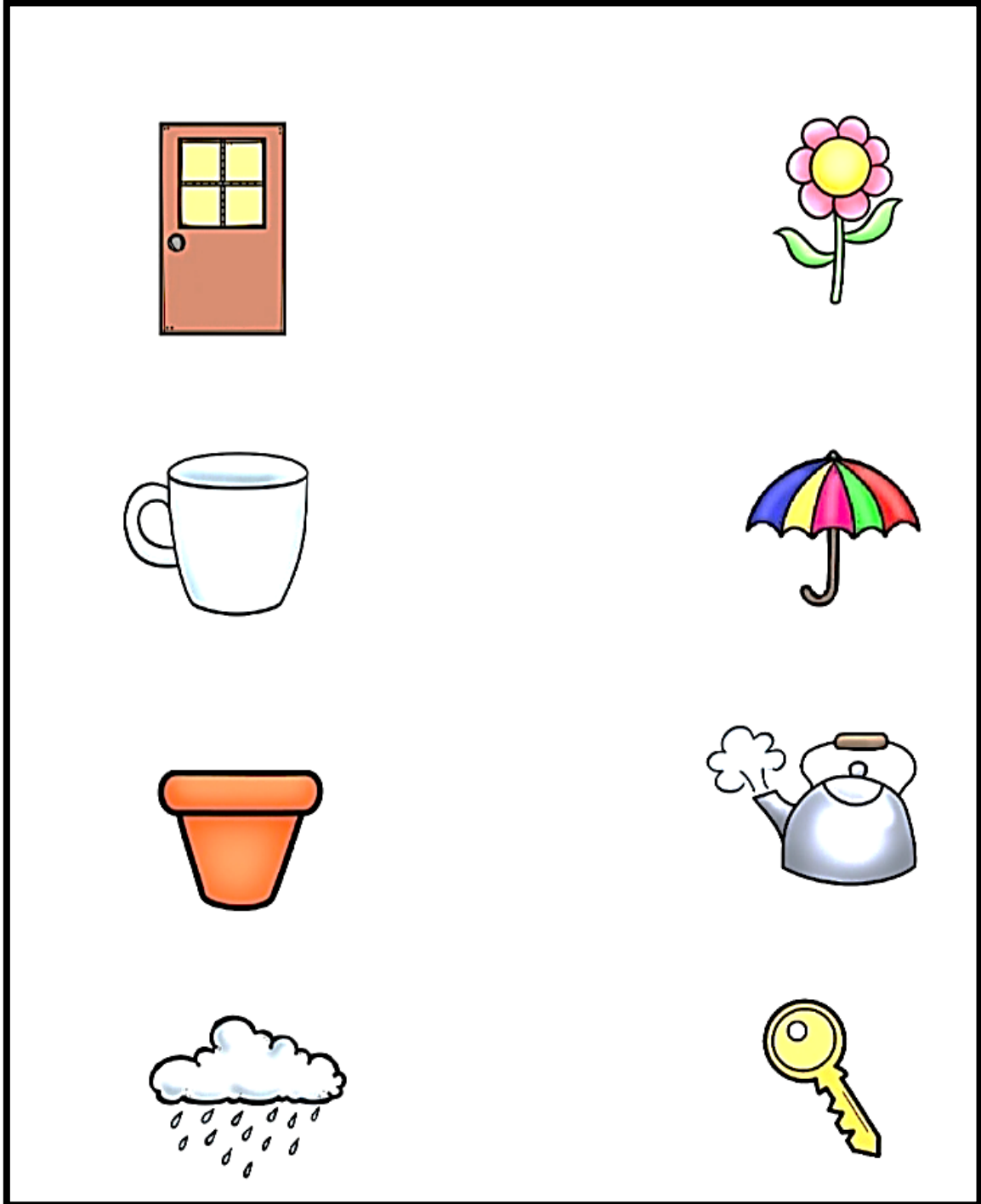

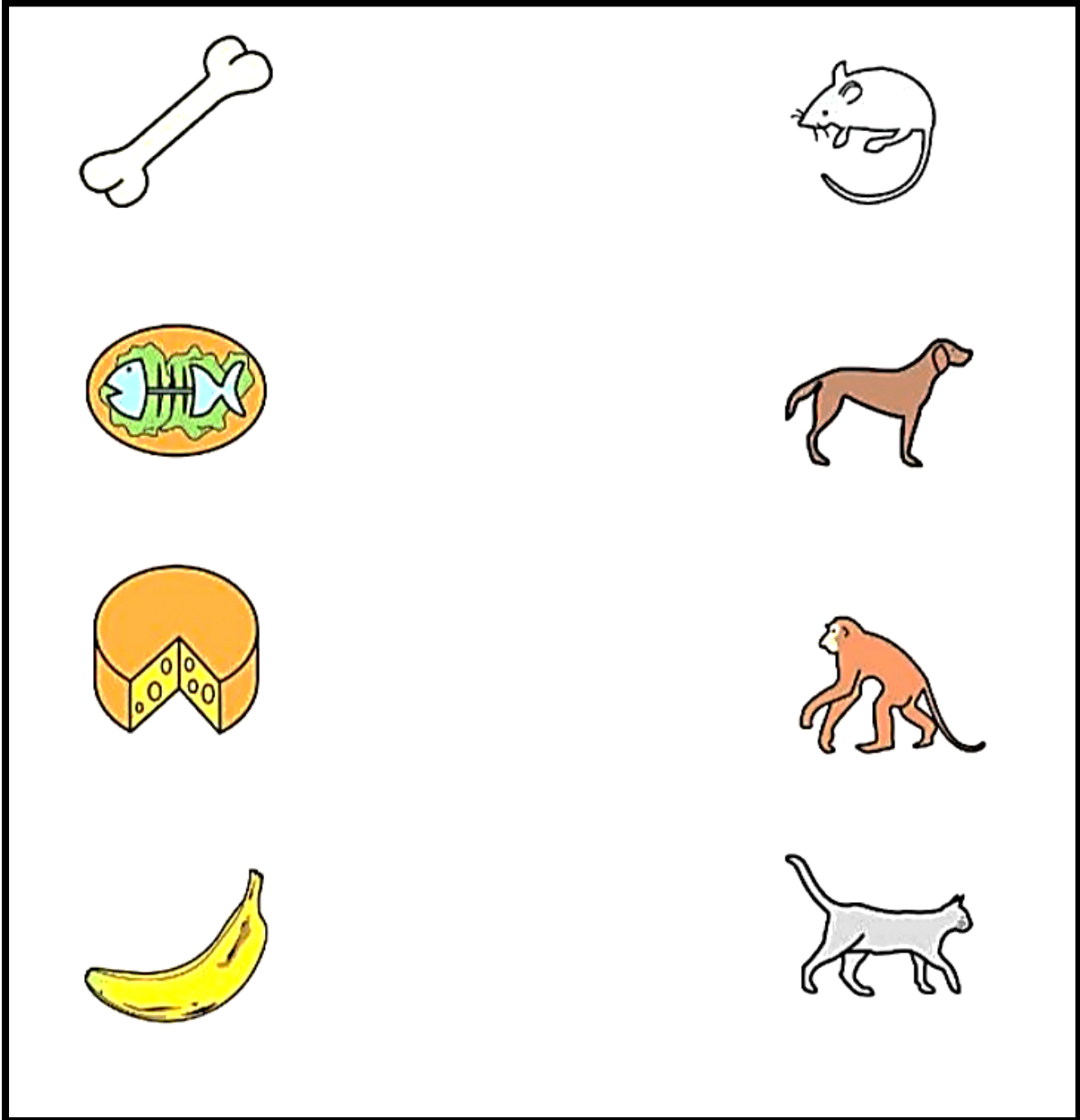

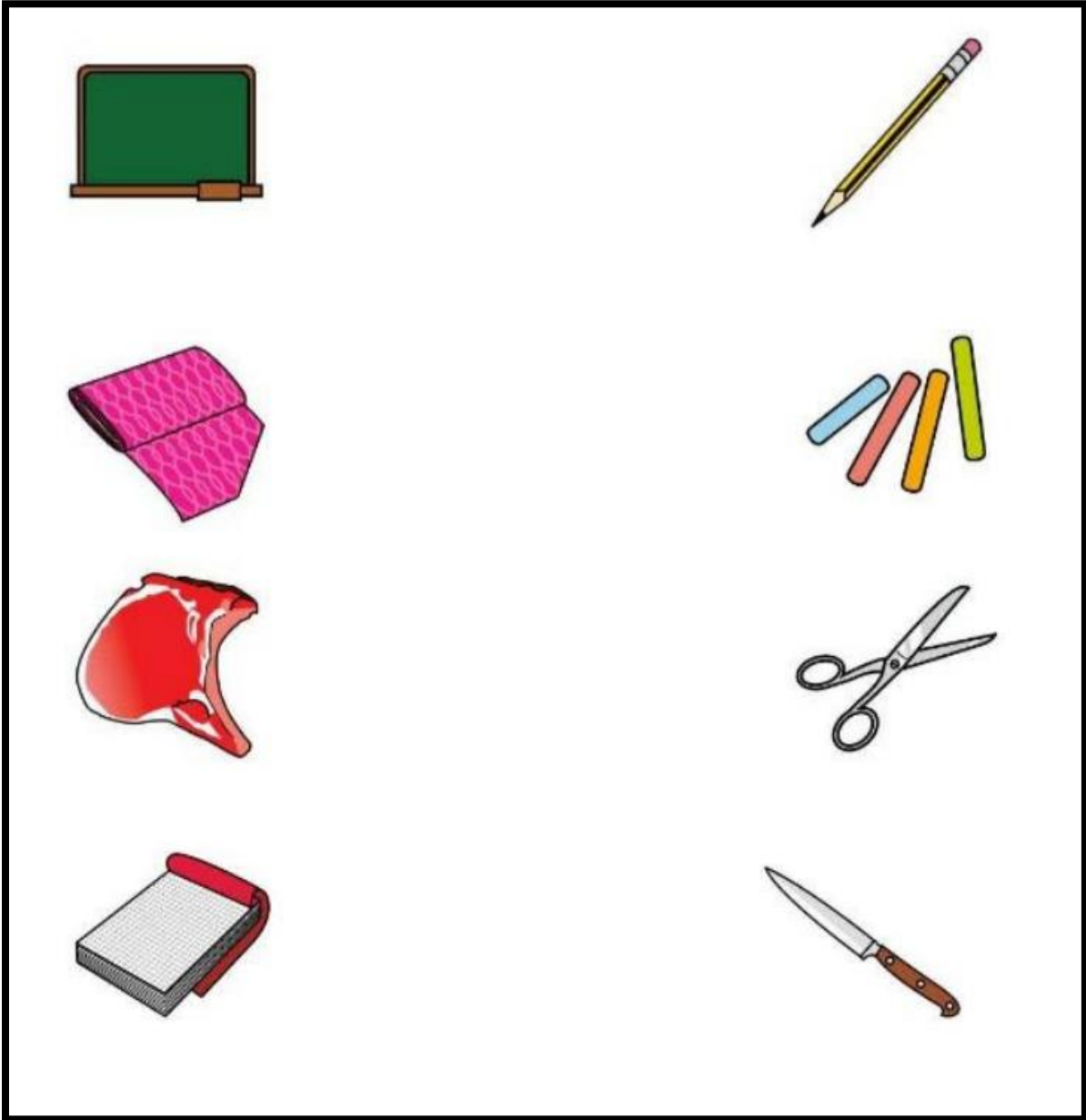

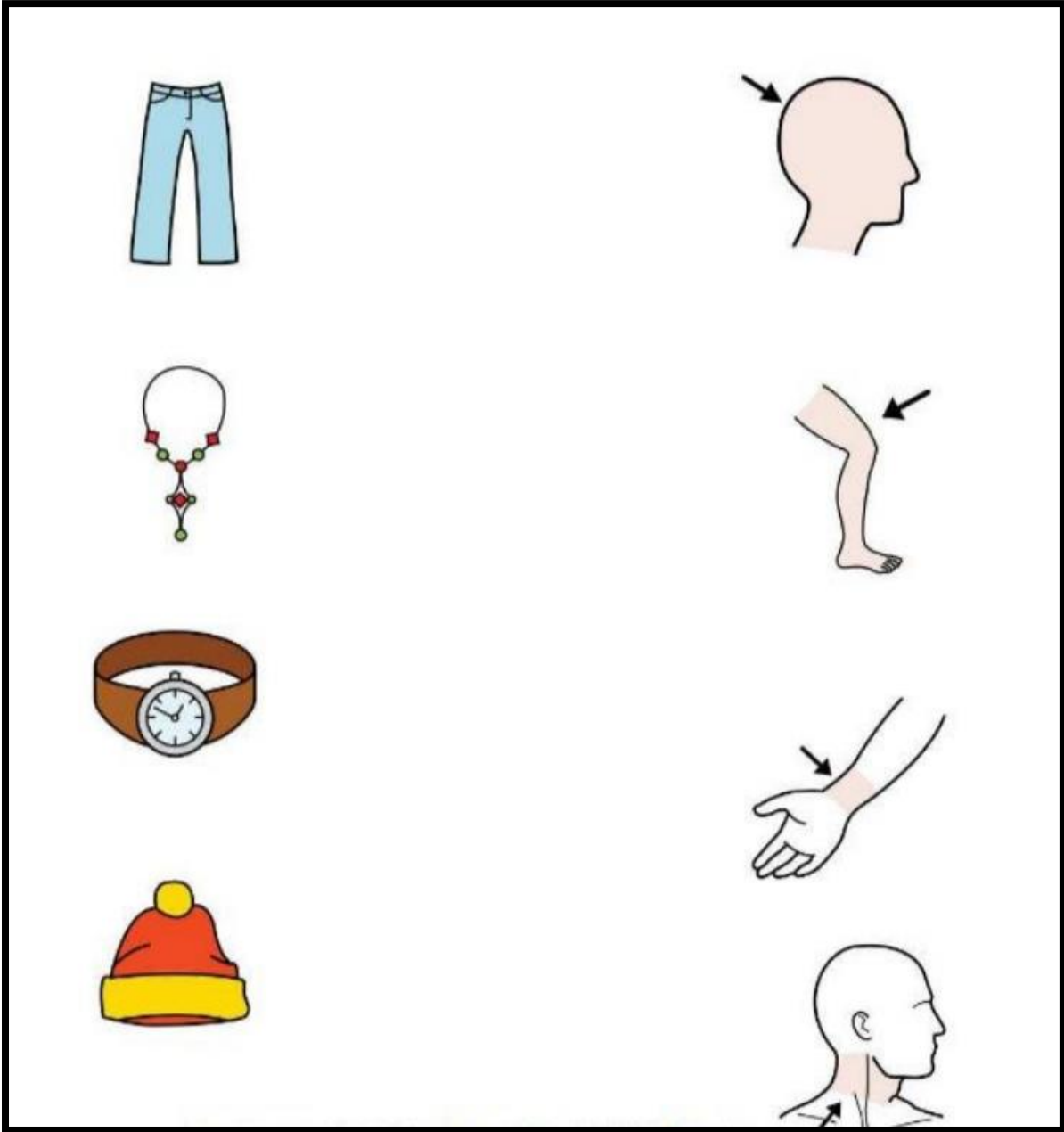

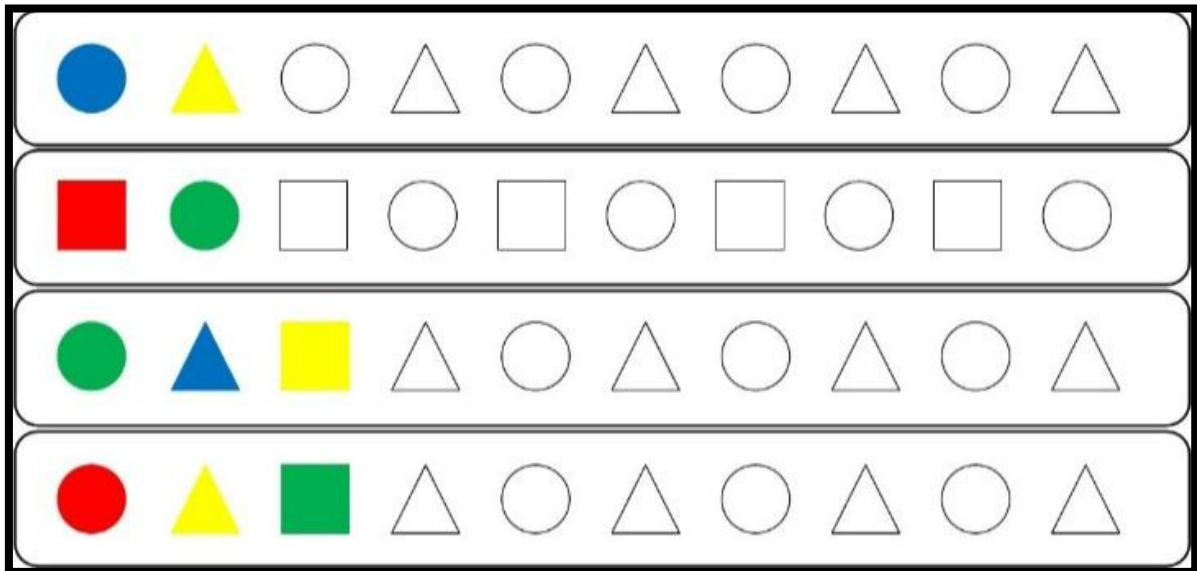
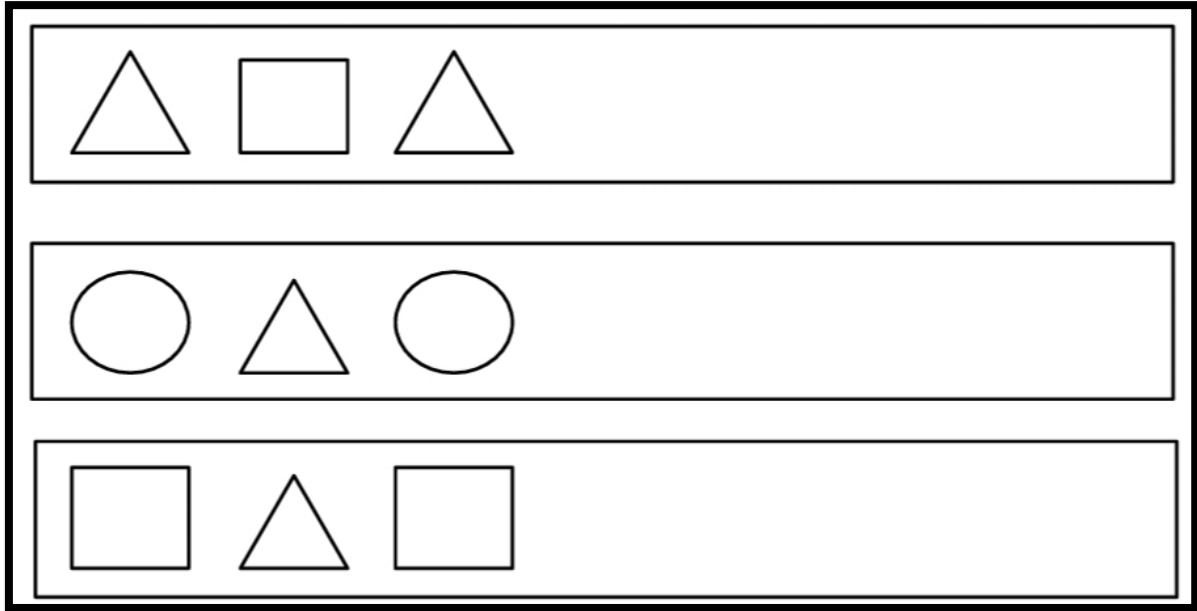

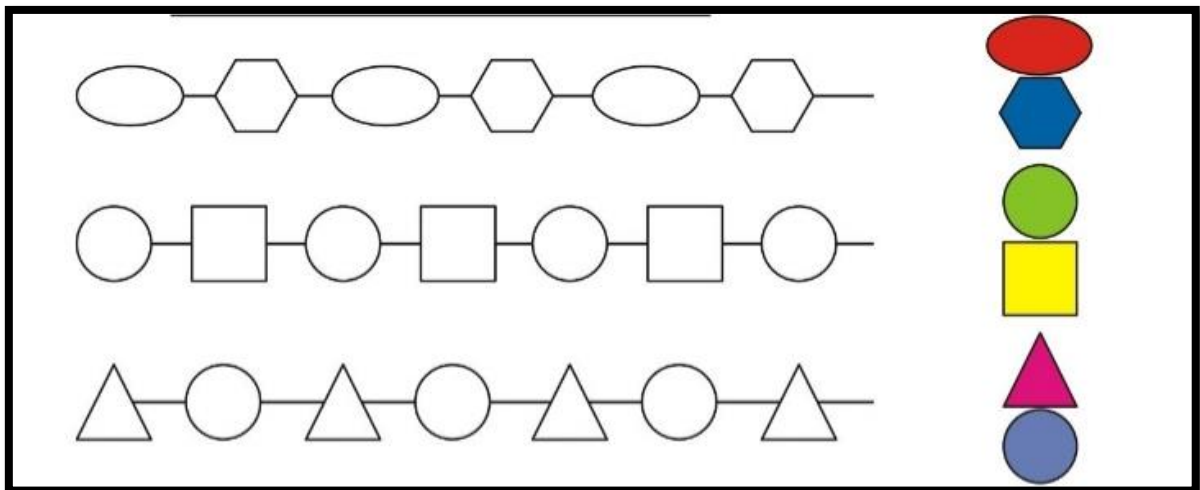
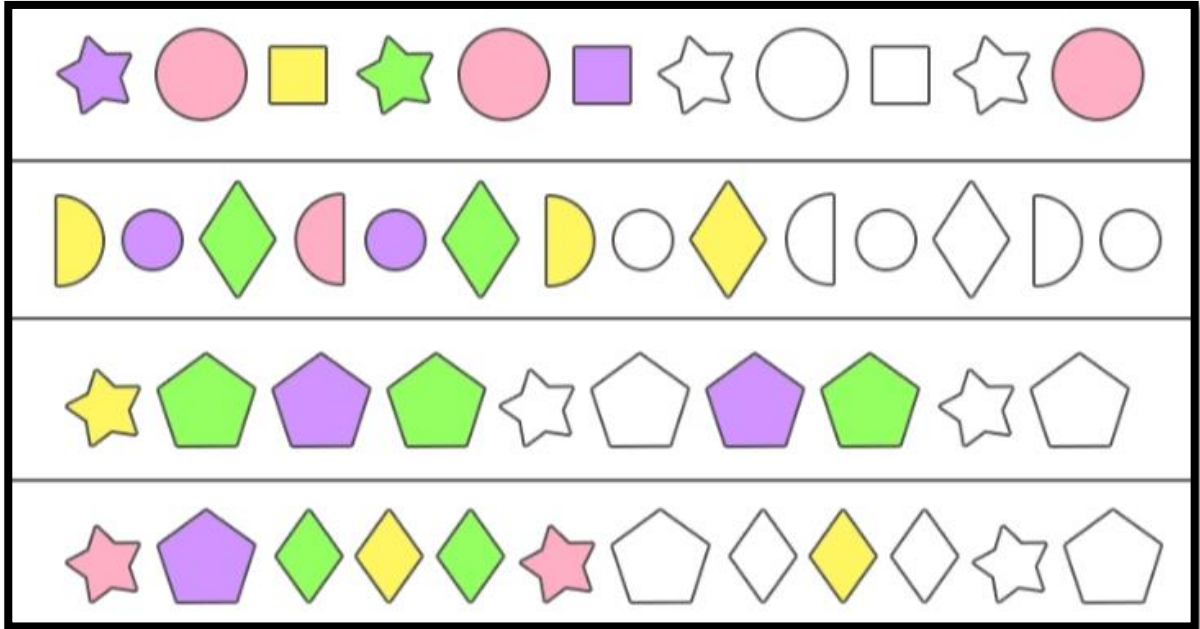

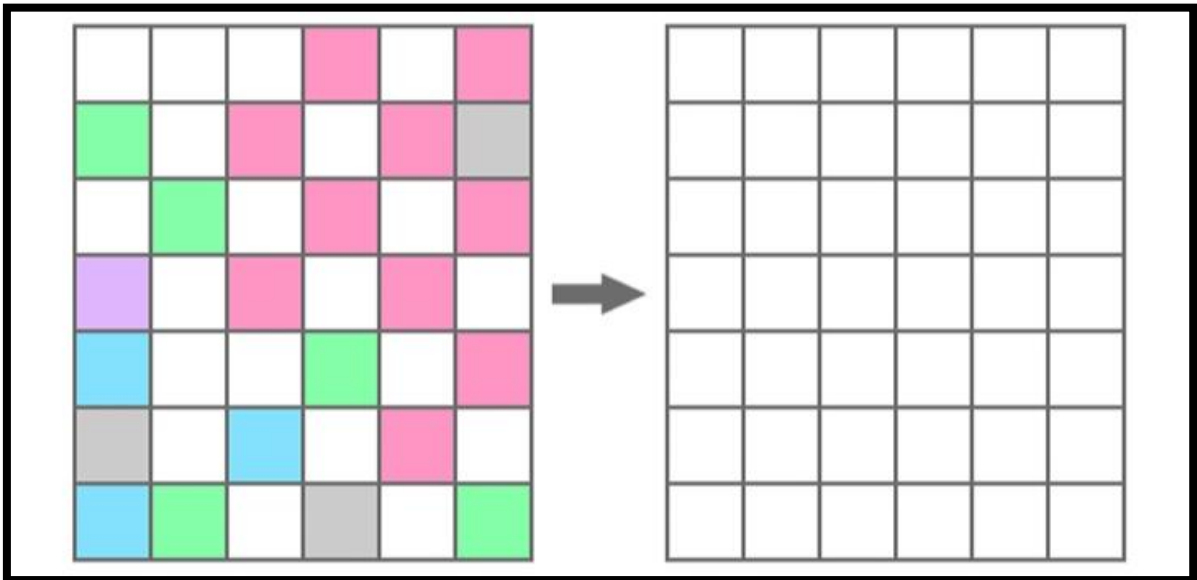
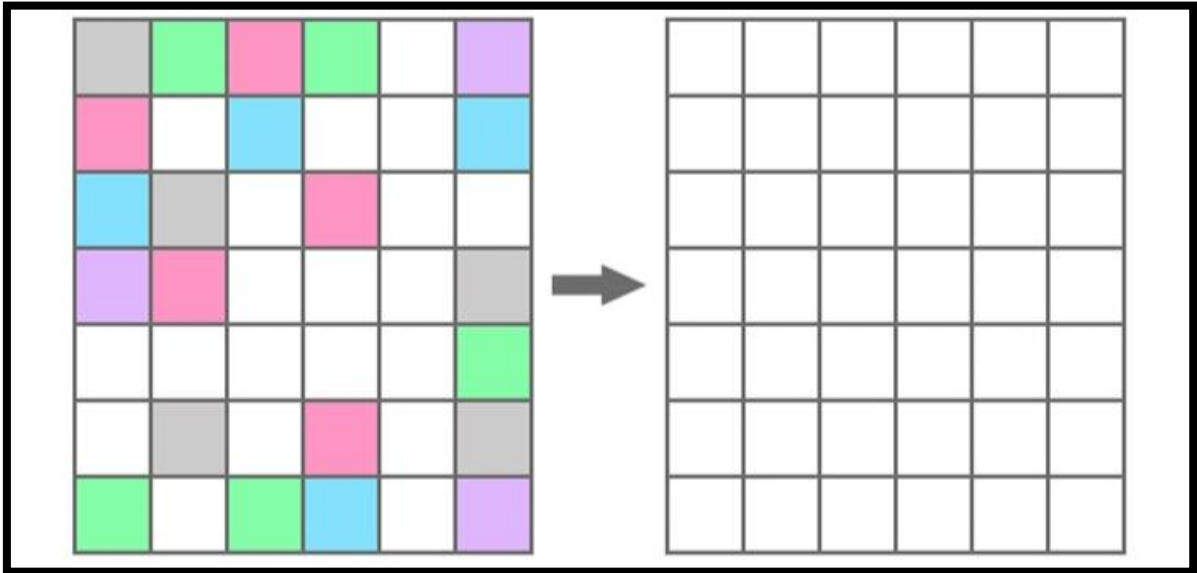

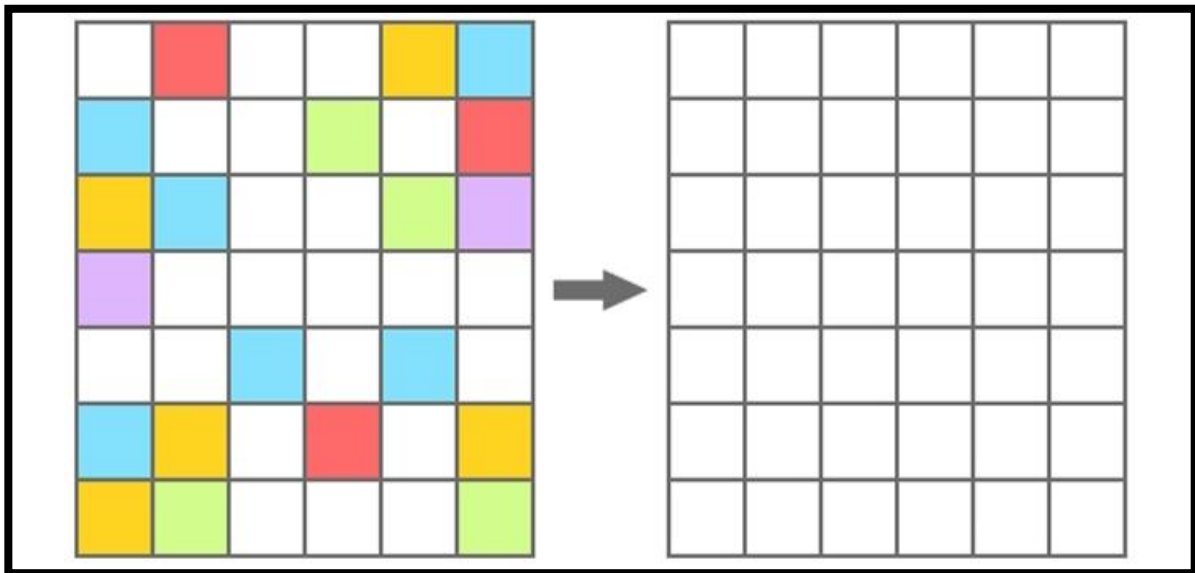
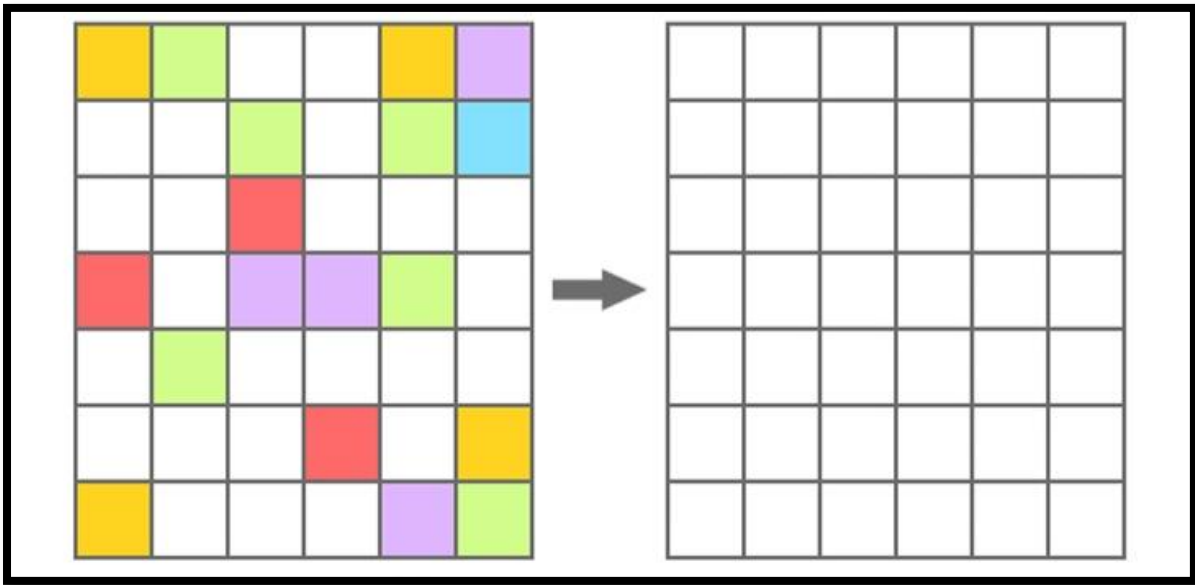

Laberintos

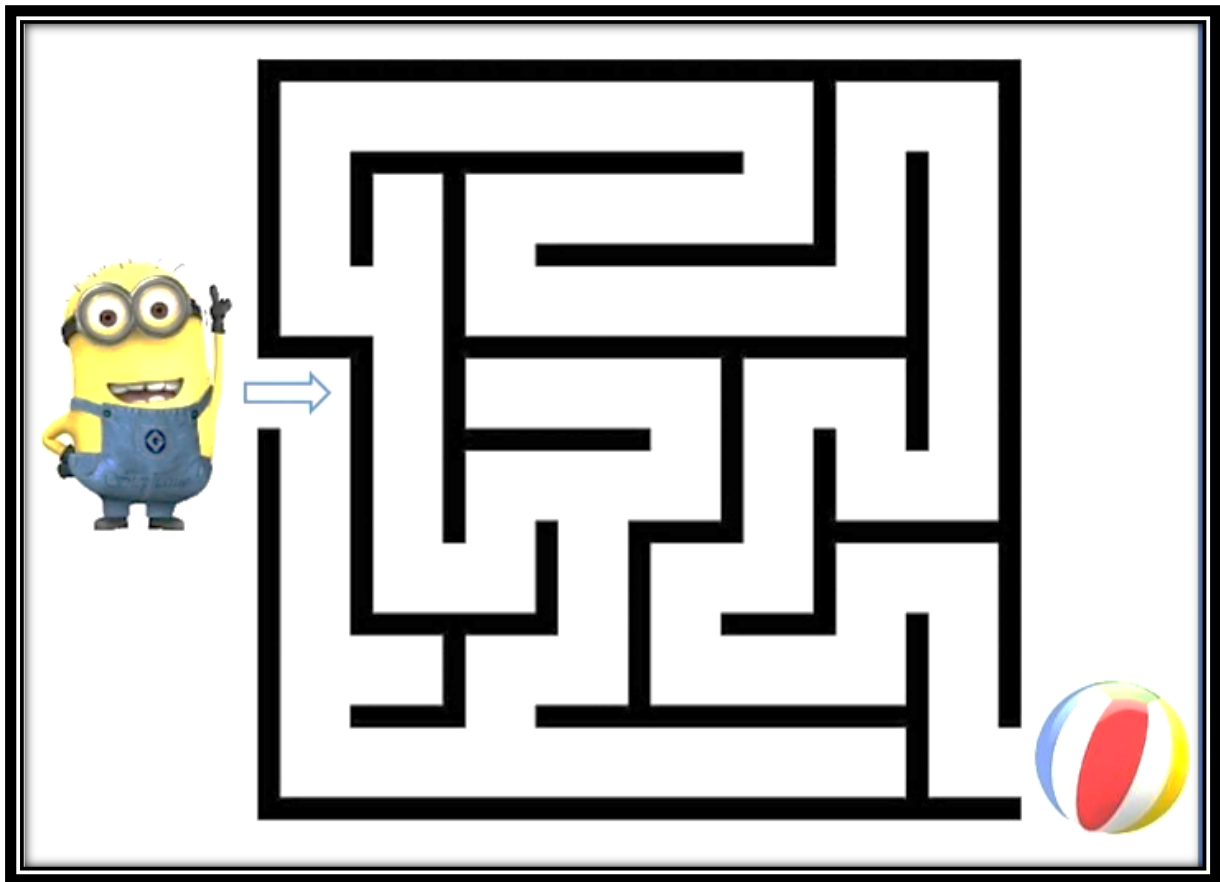

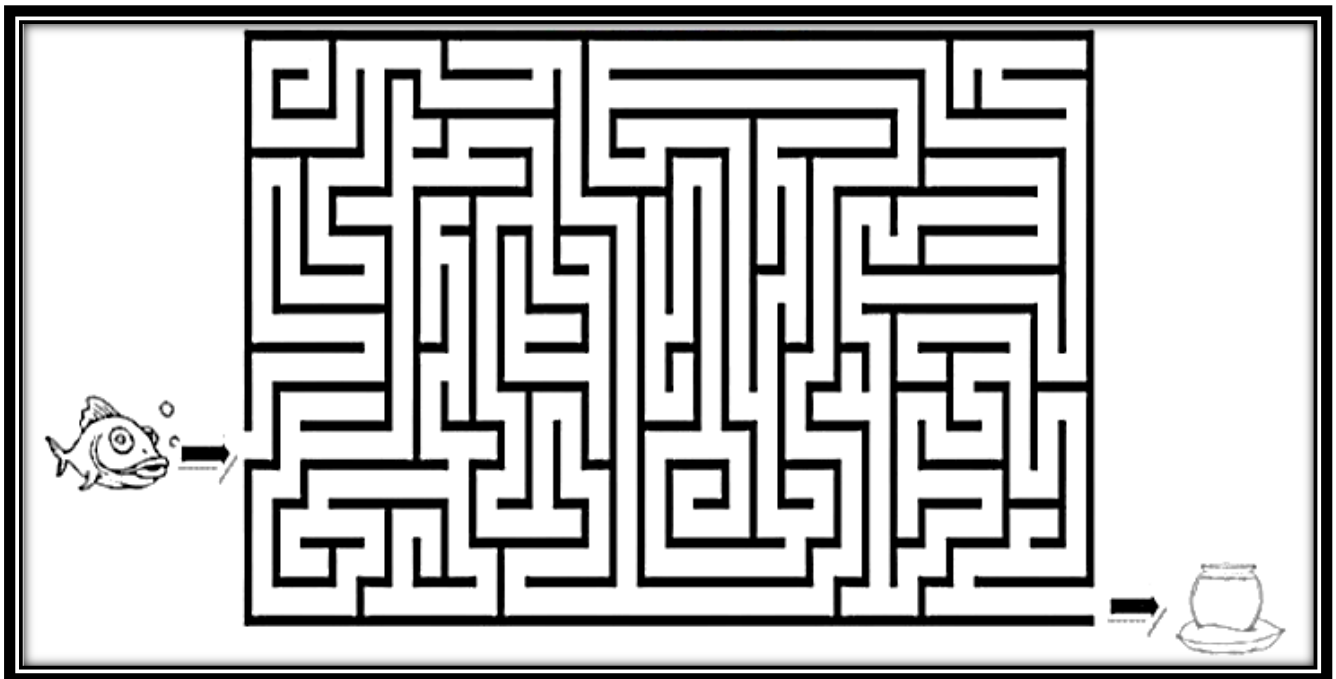
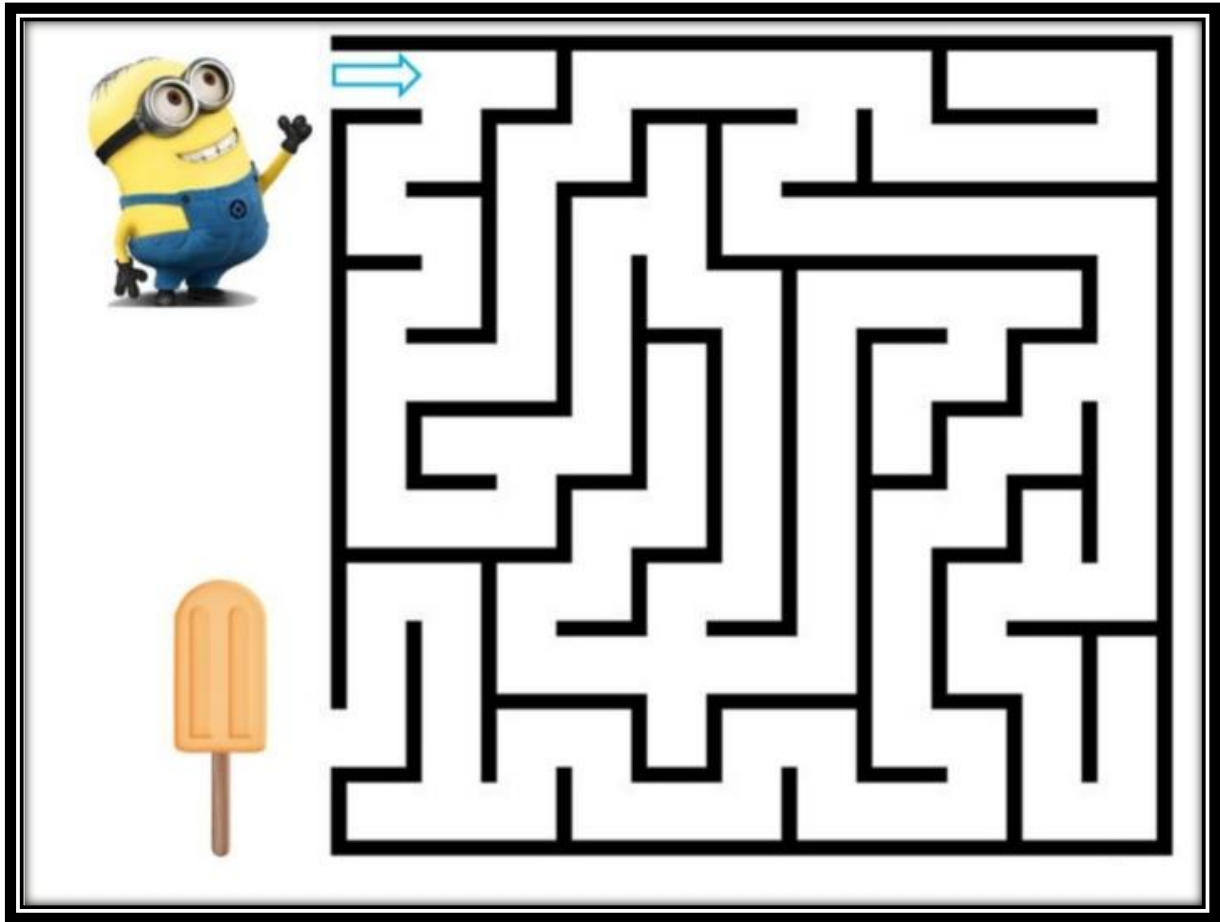

Encuentra las diferencias

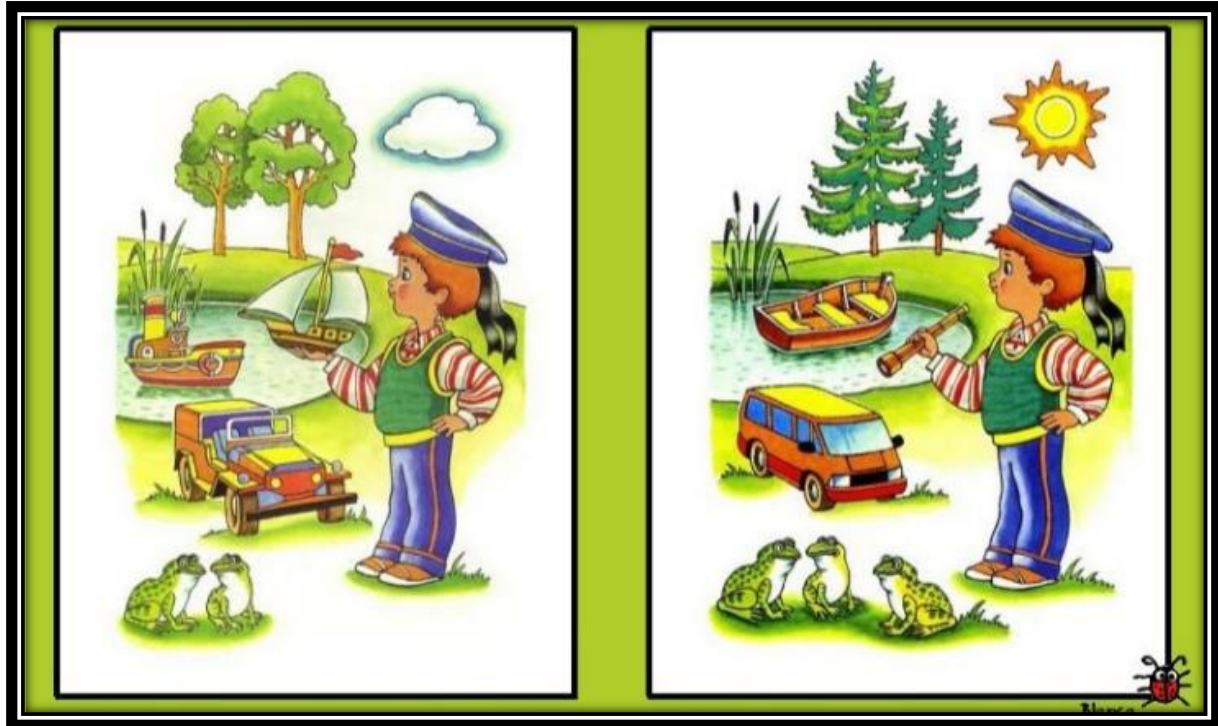

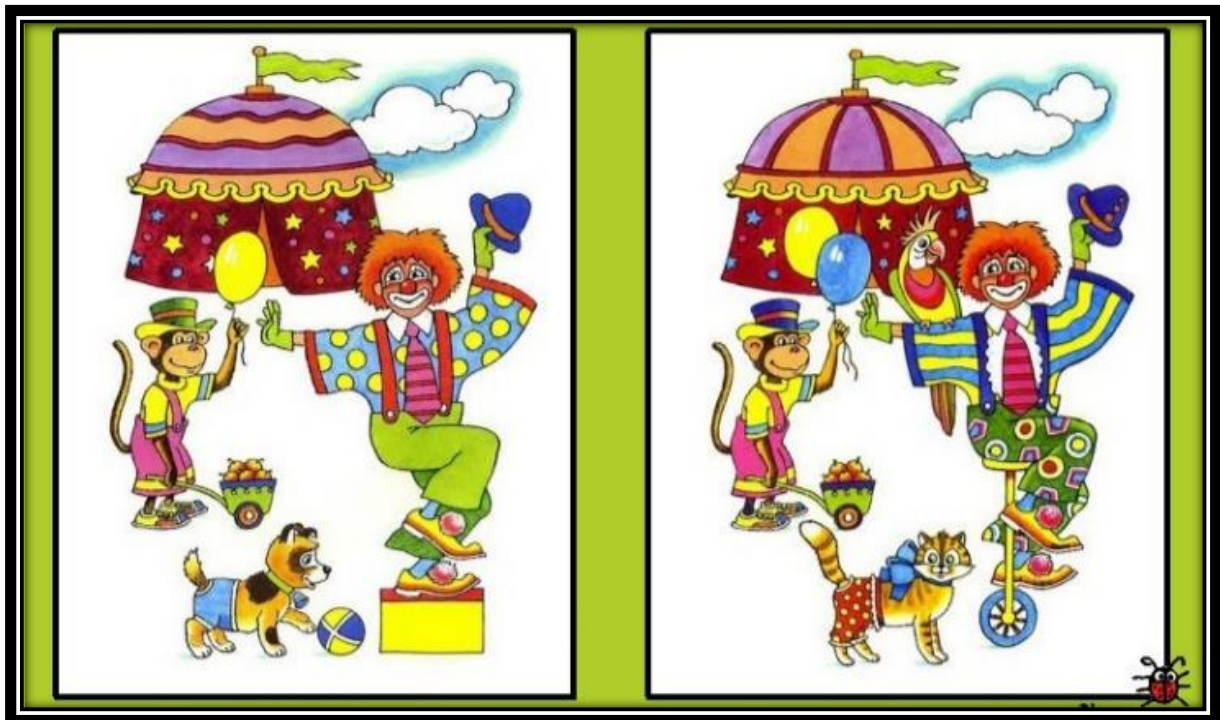
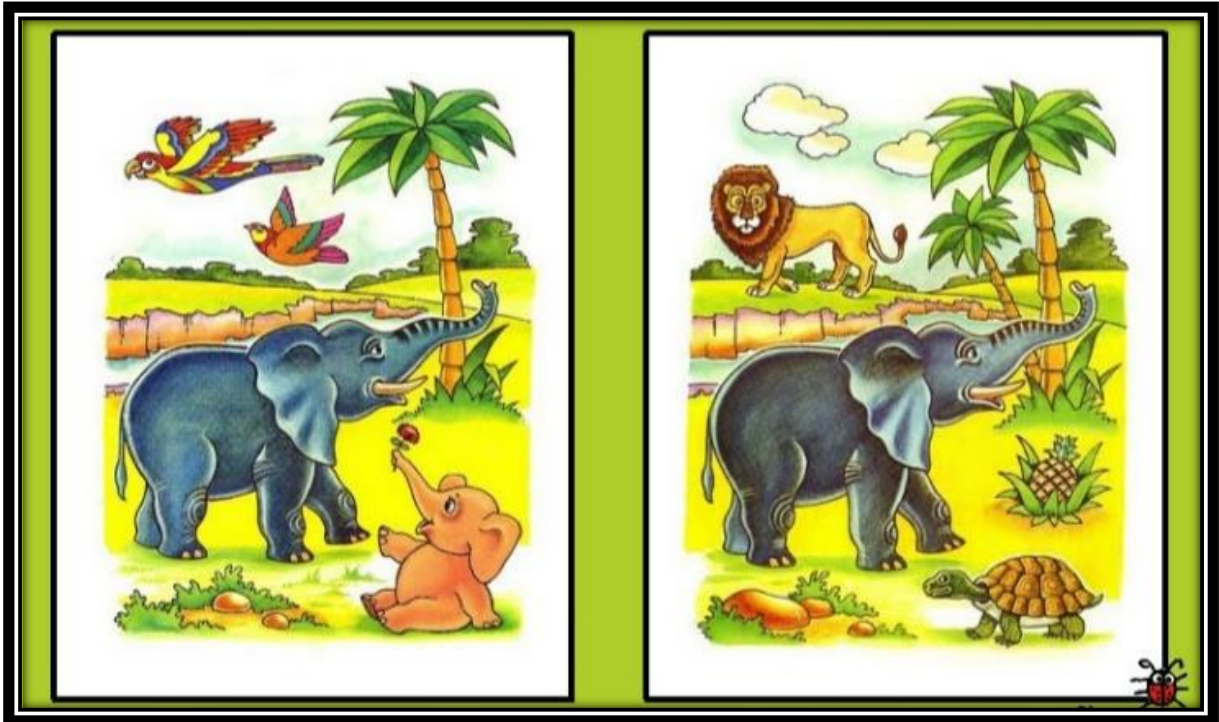

Búsqueda de objetos











Grafo motricidad

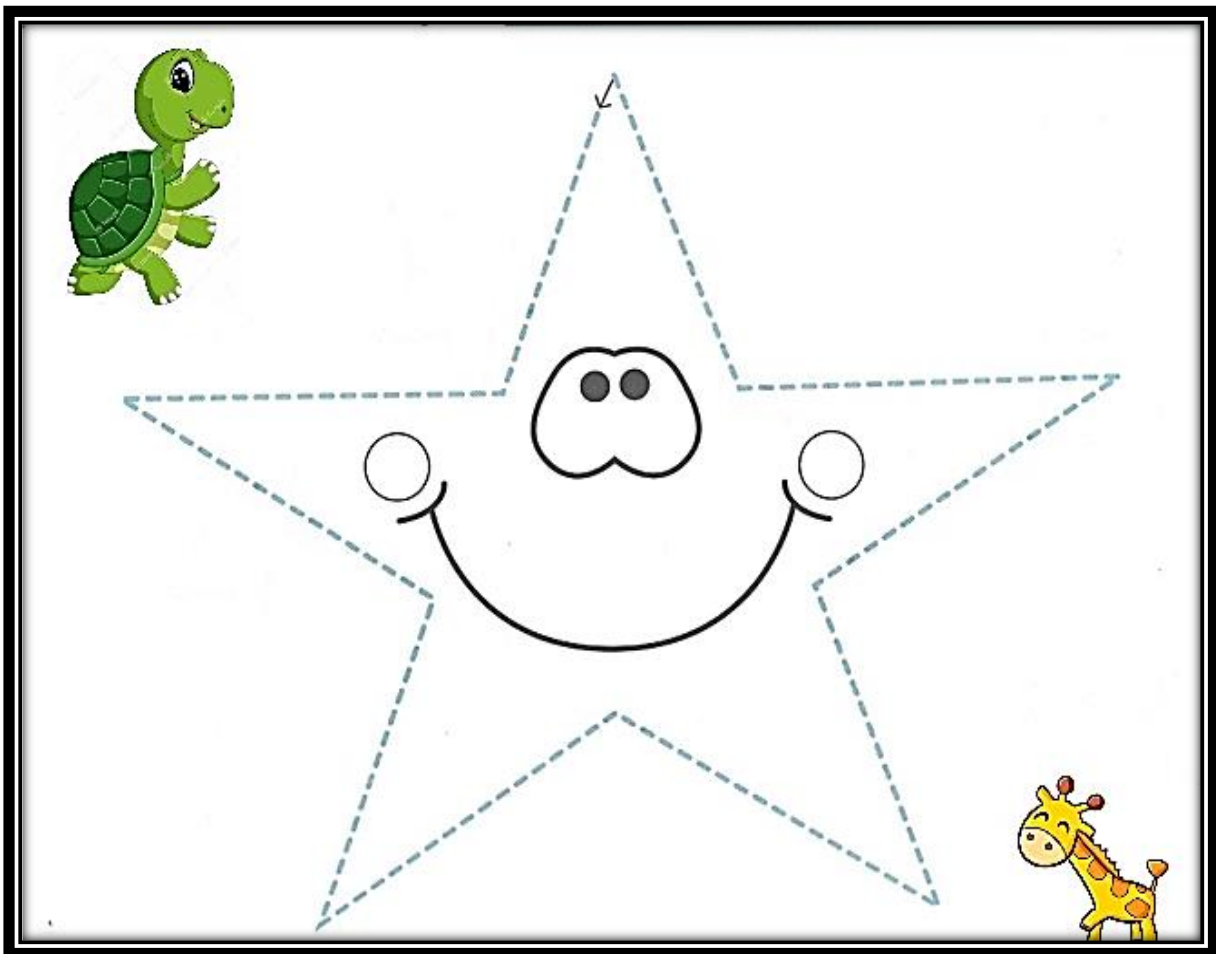

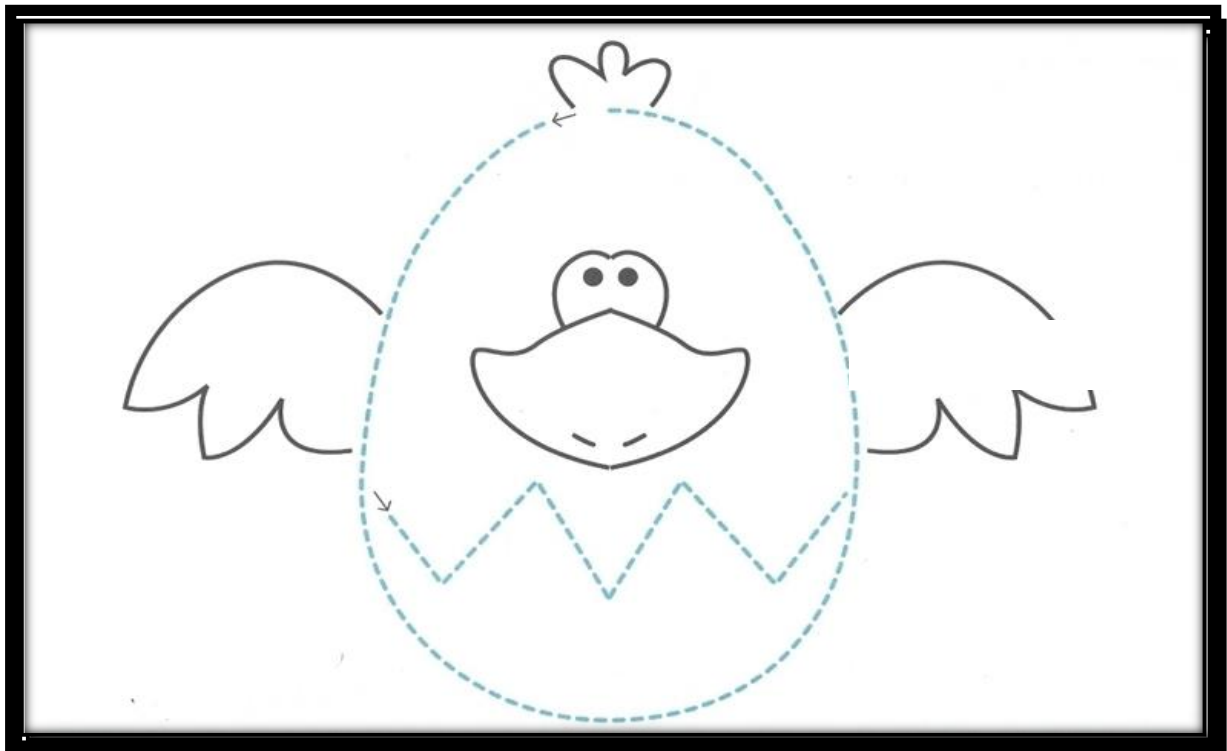
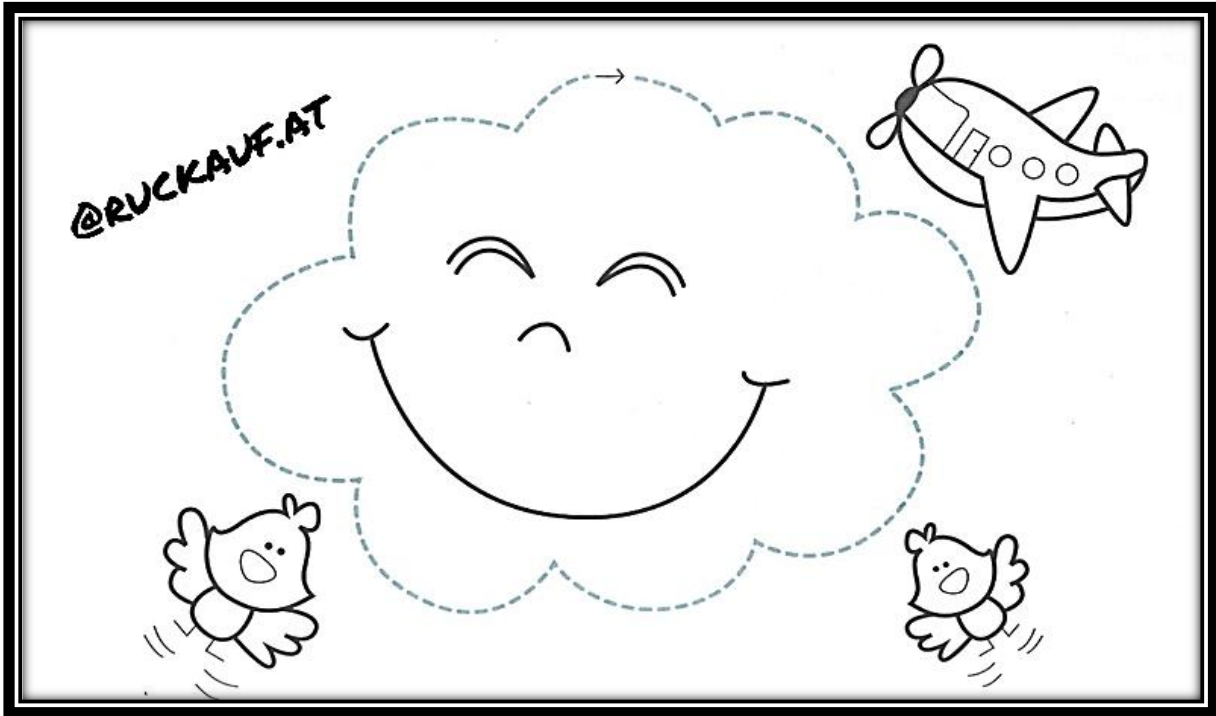

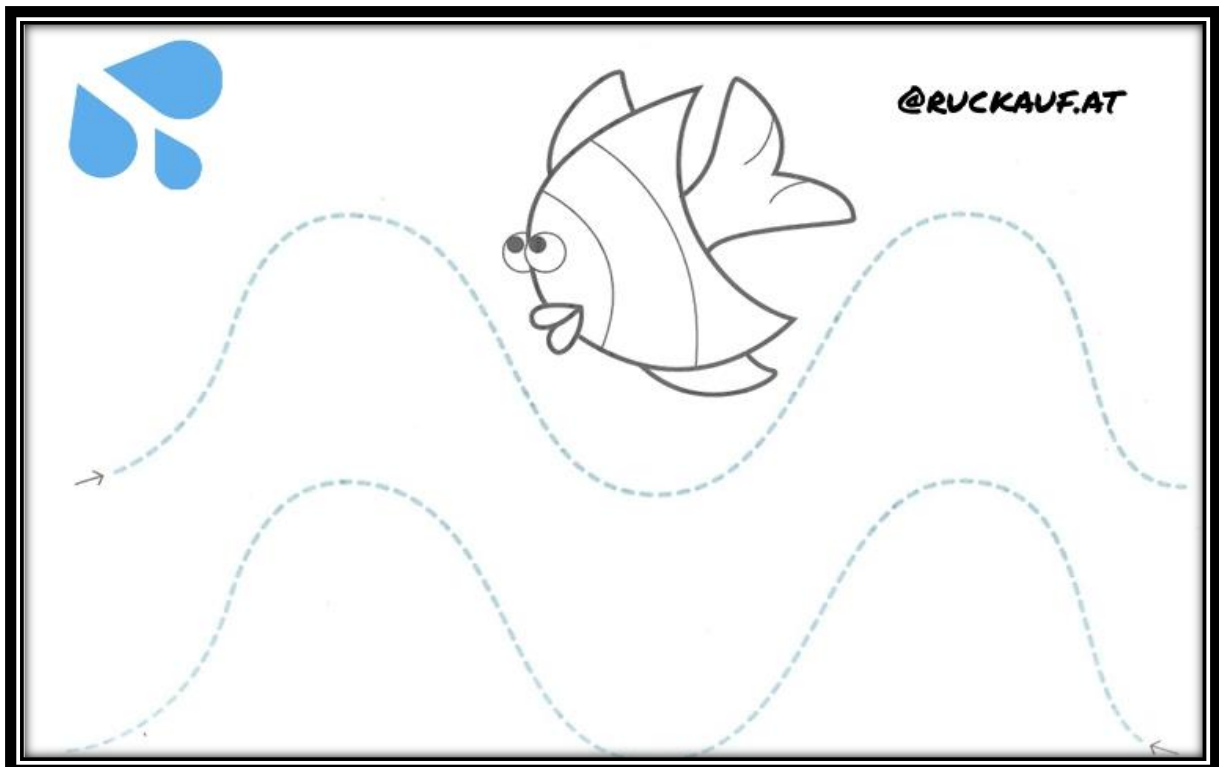
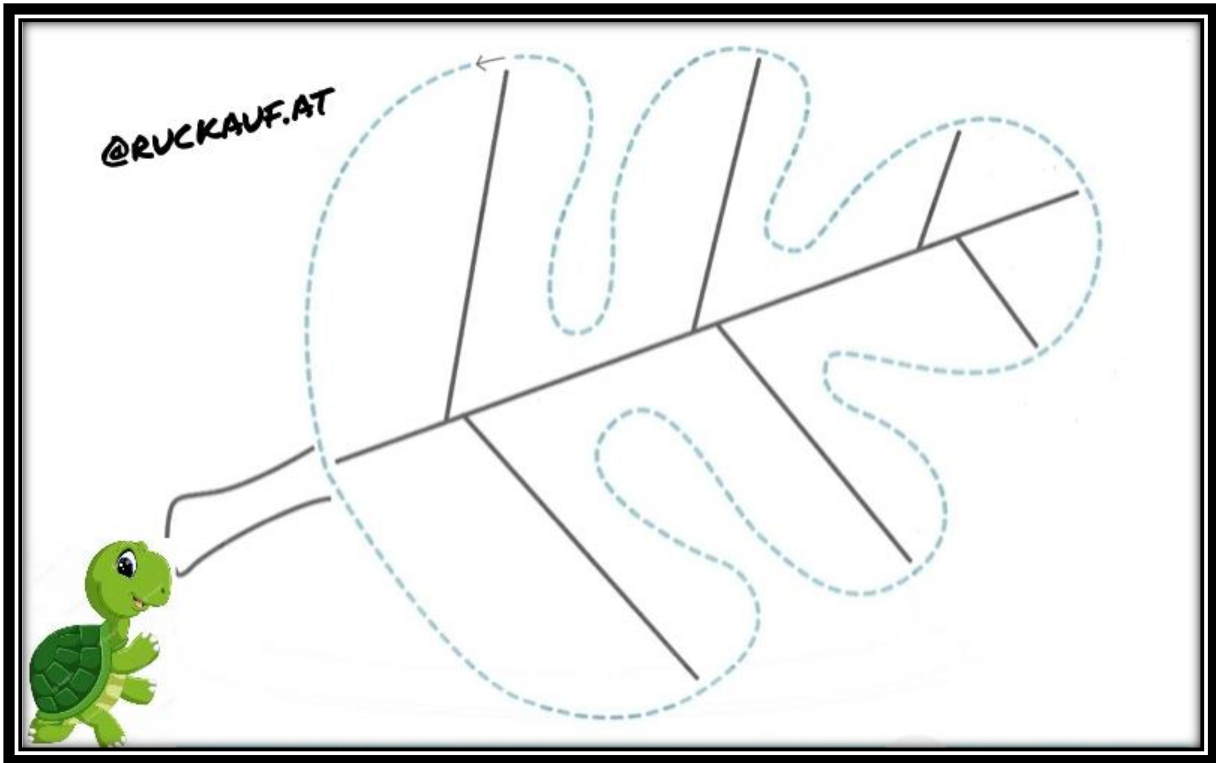

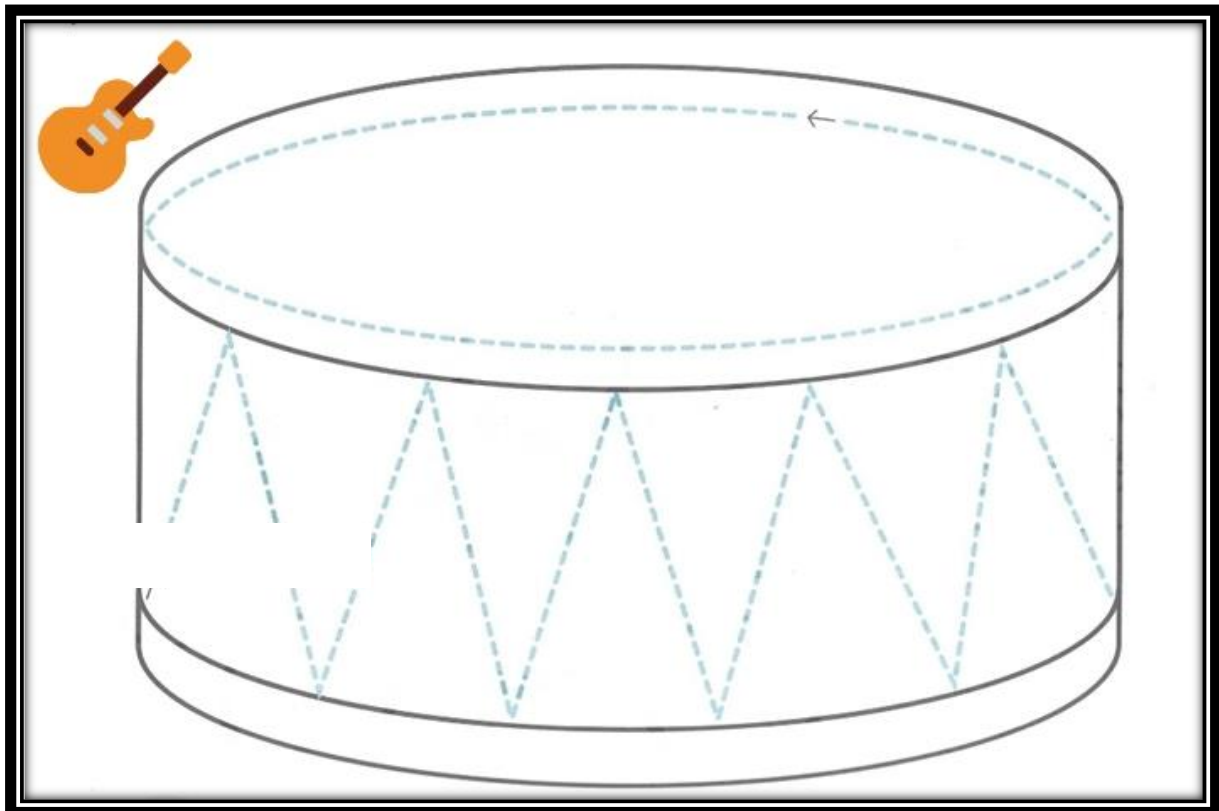
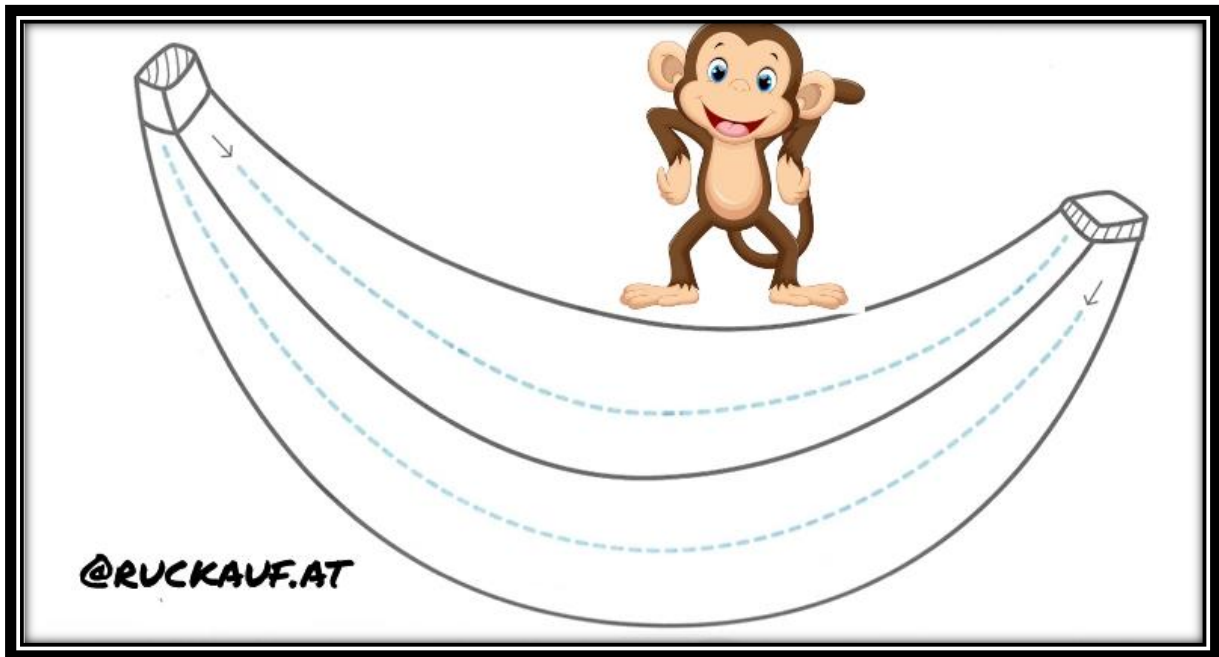

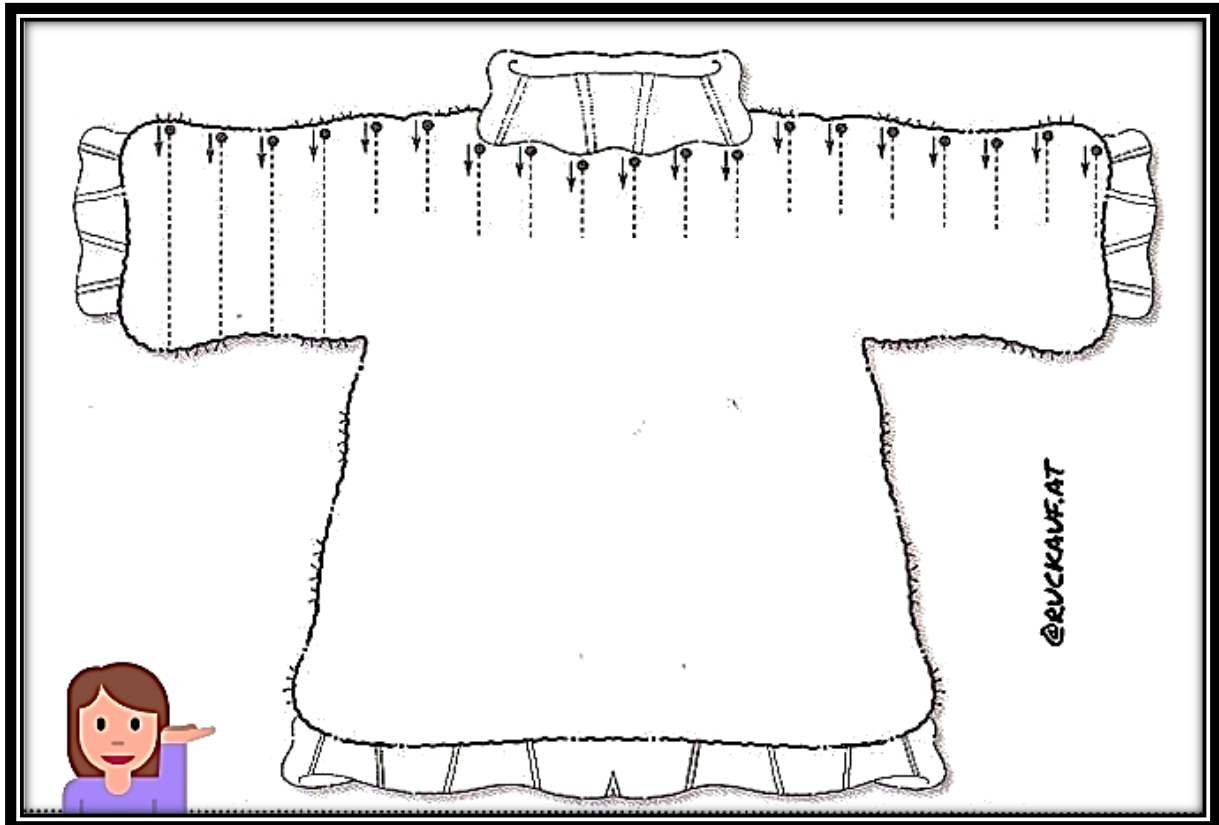
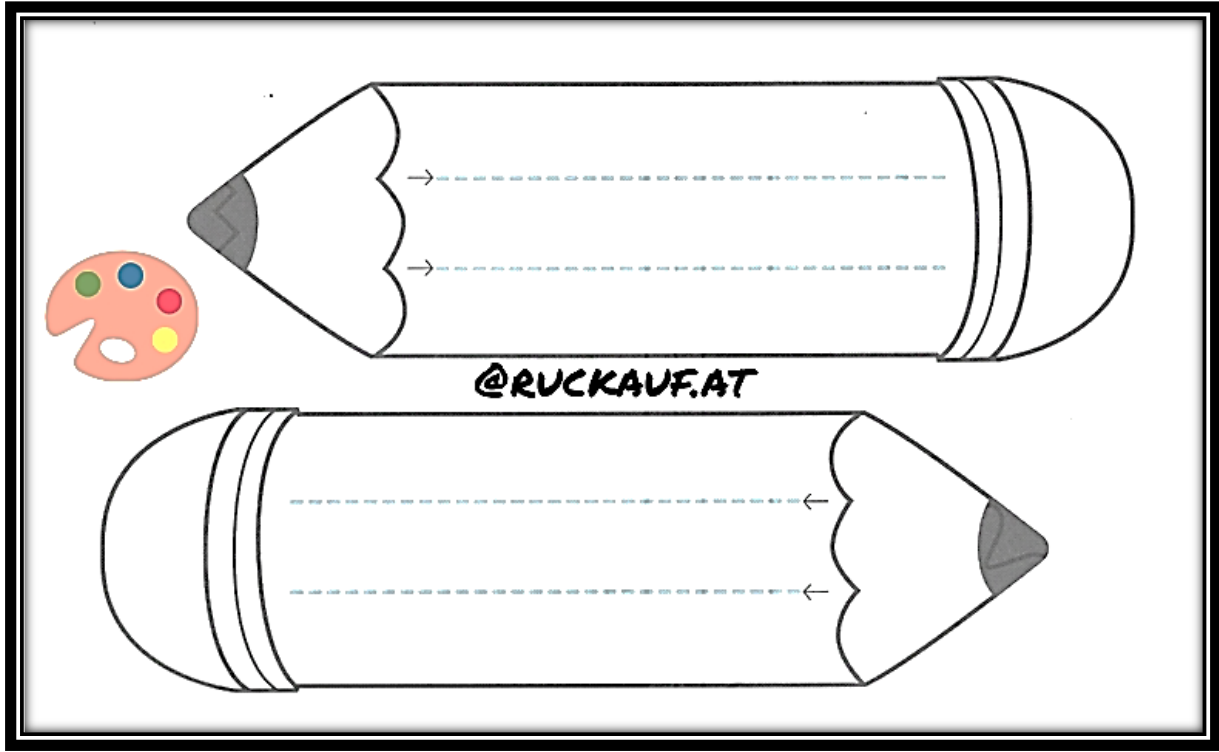

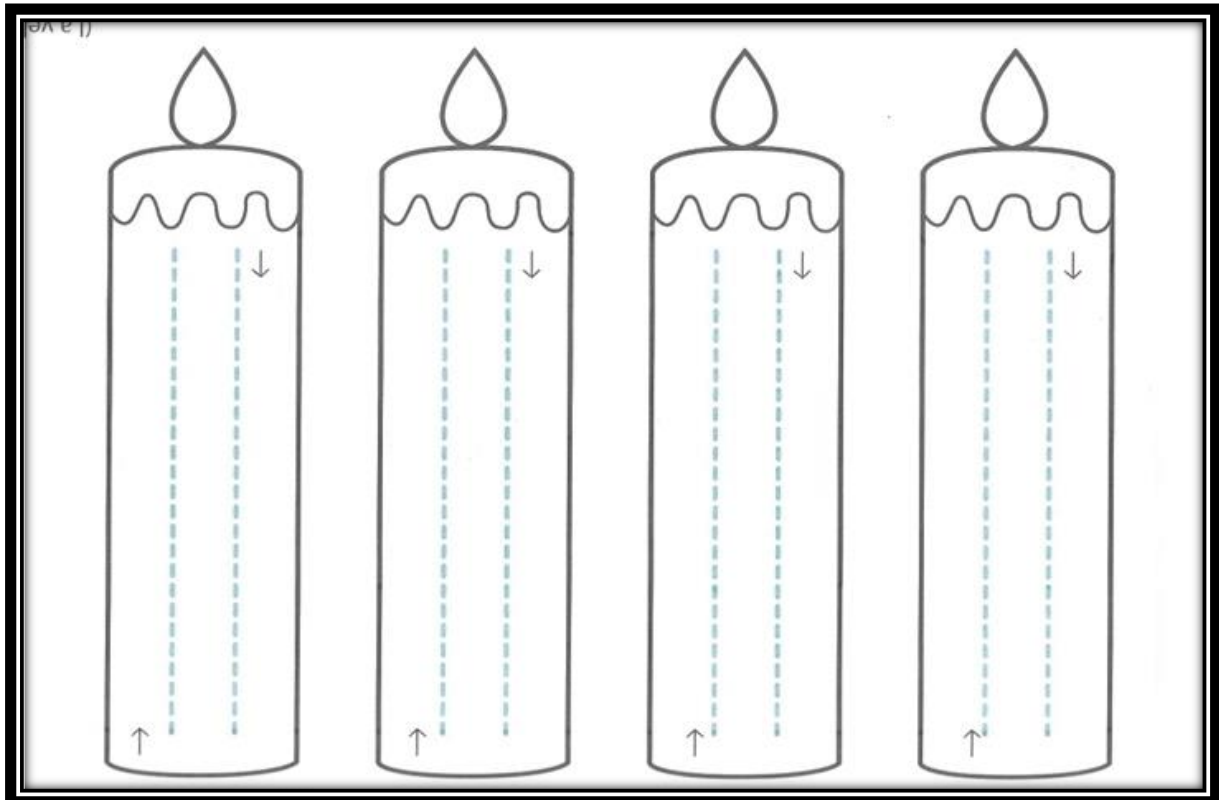
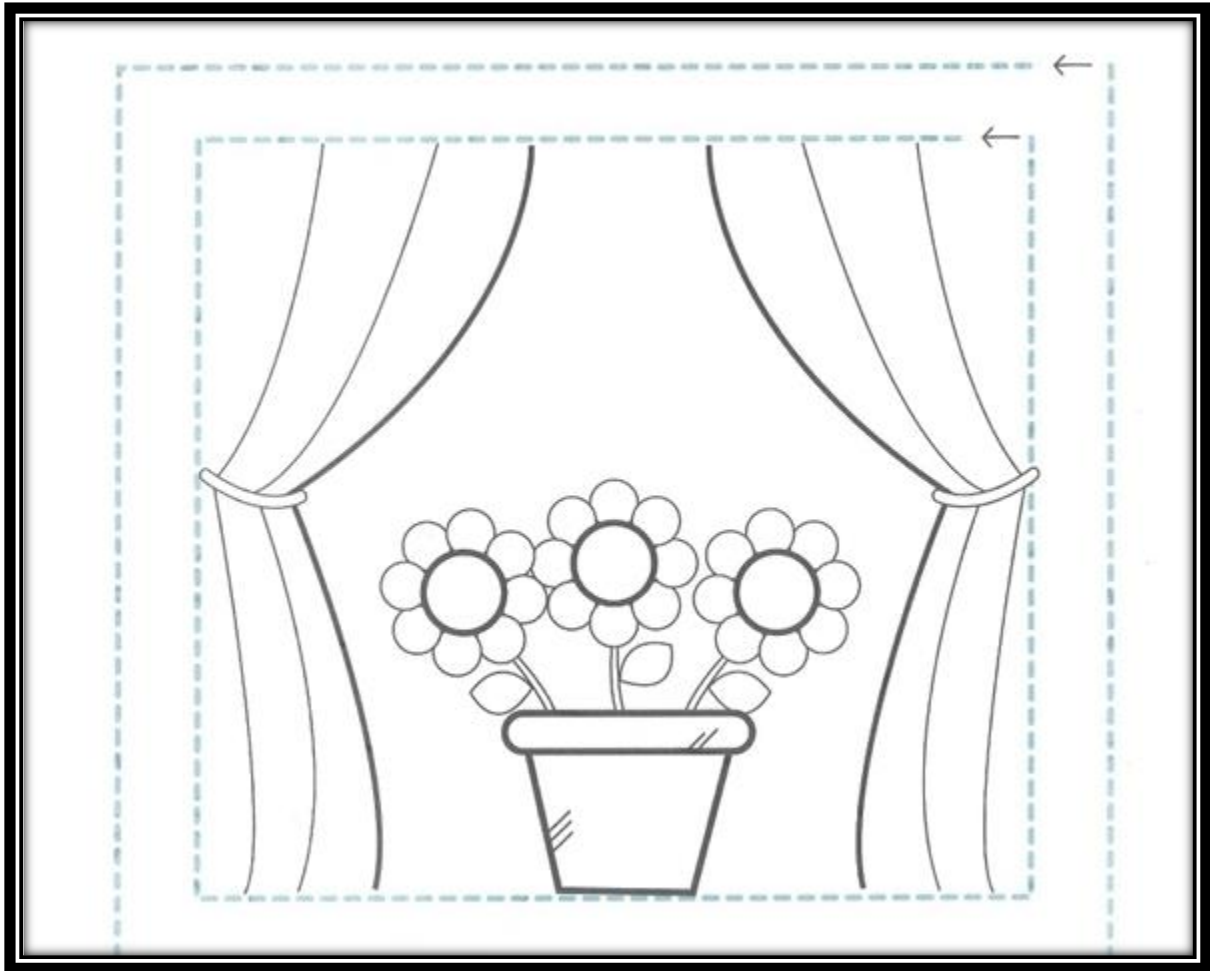

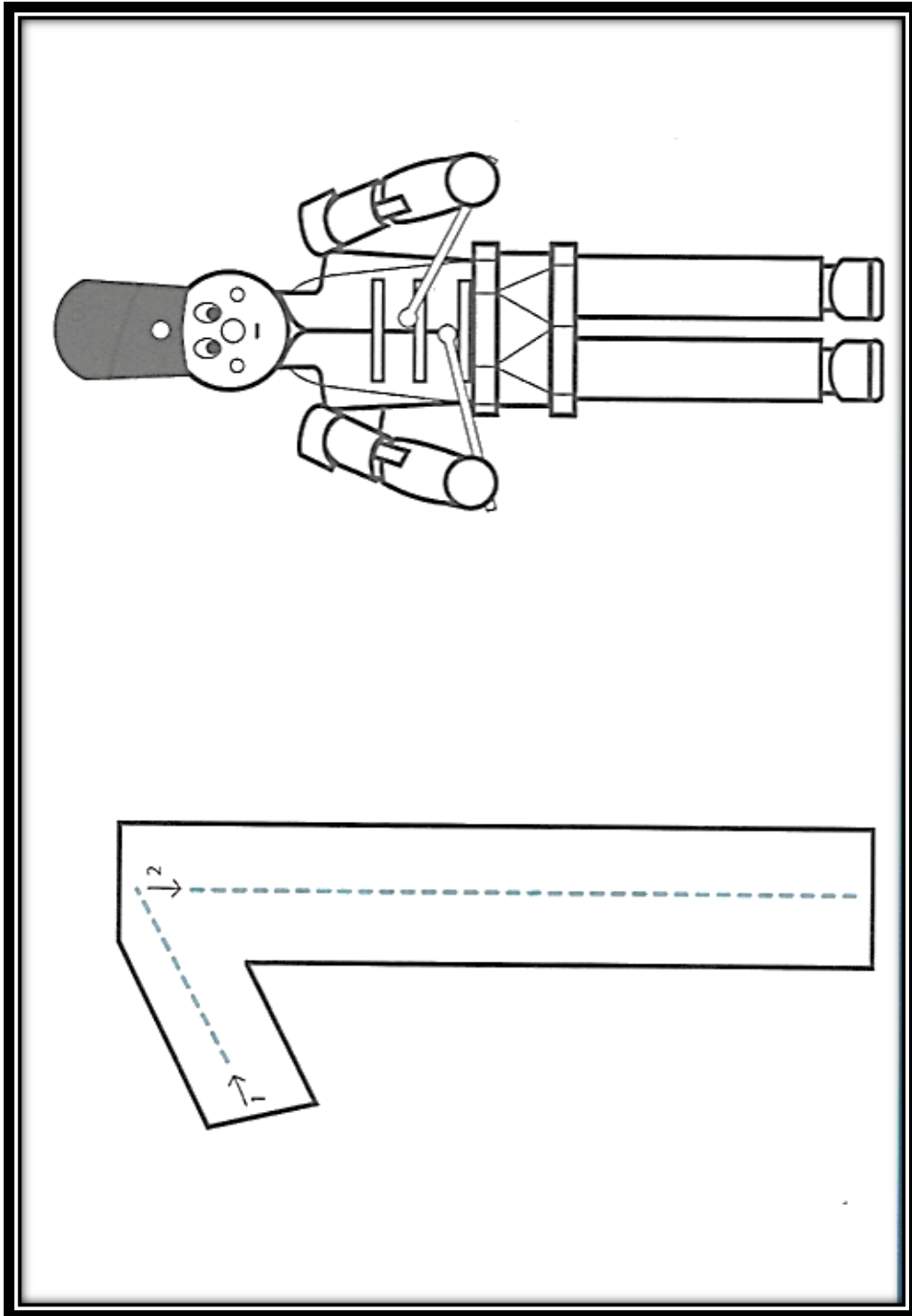

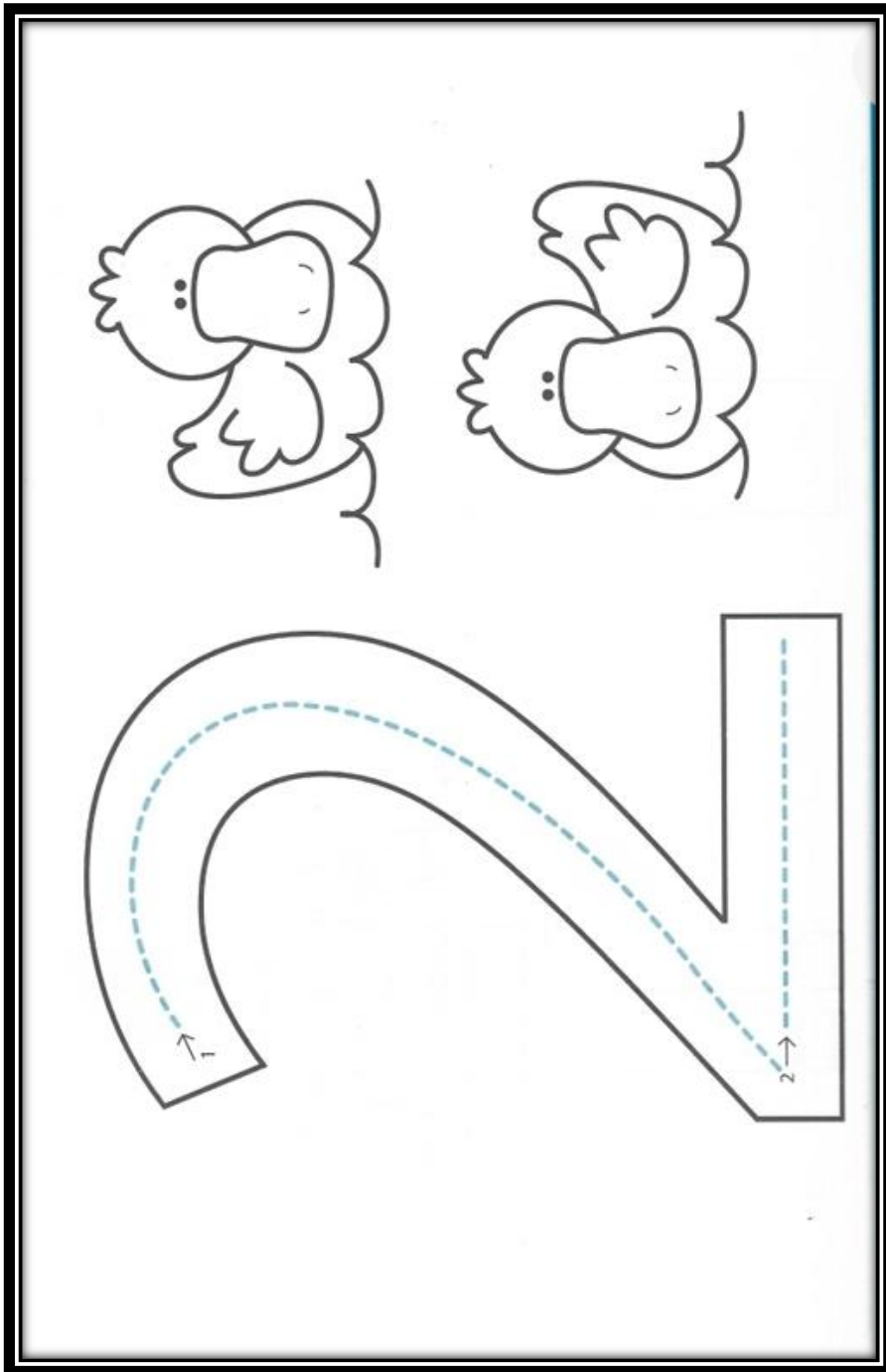

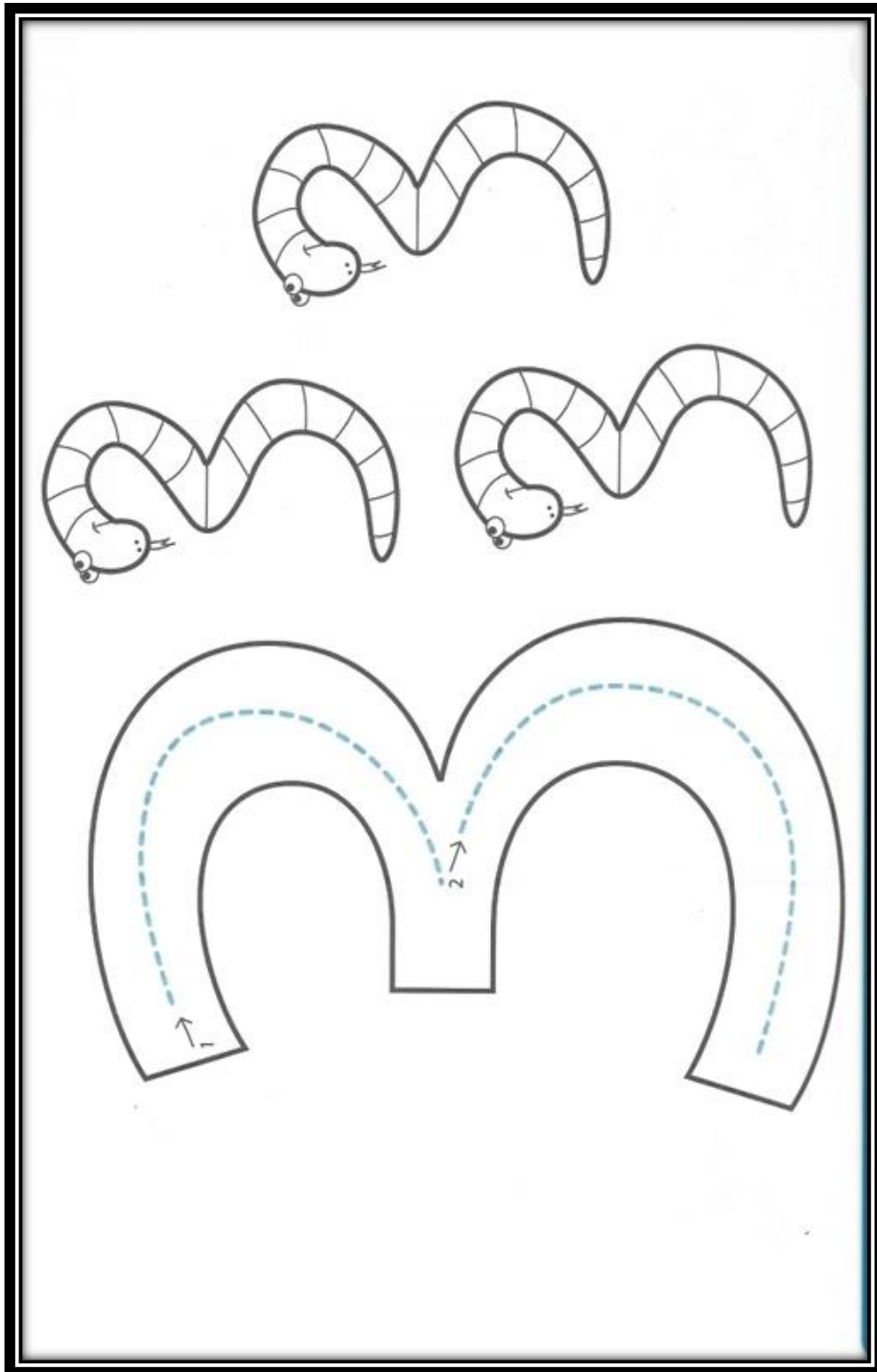

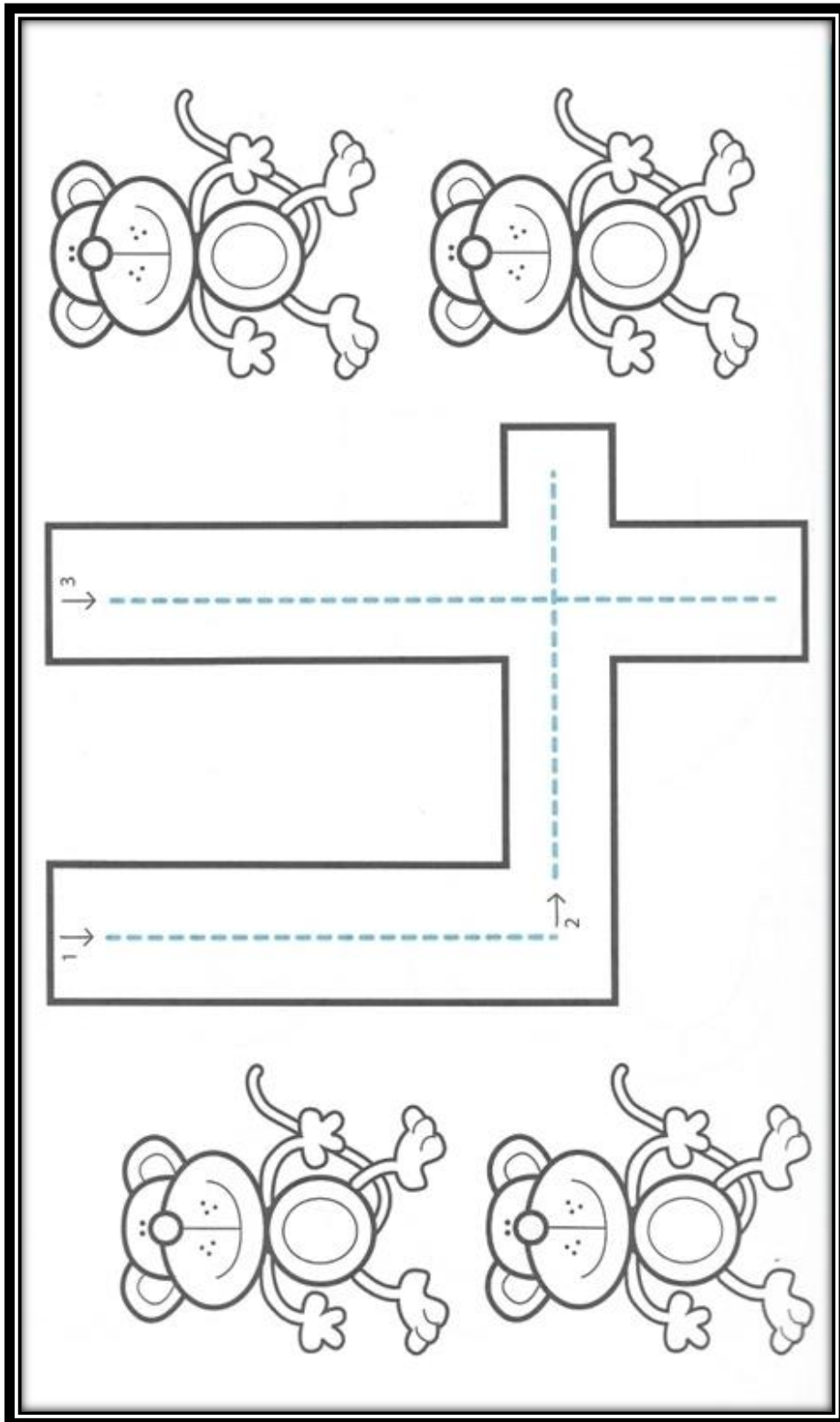

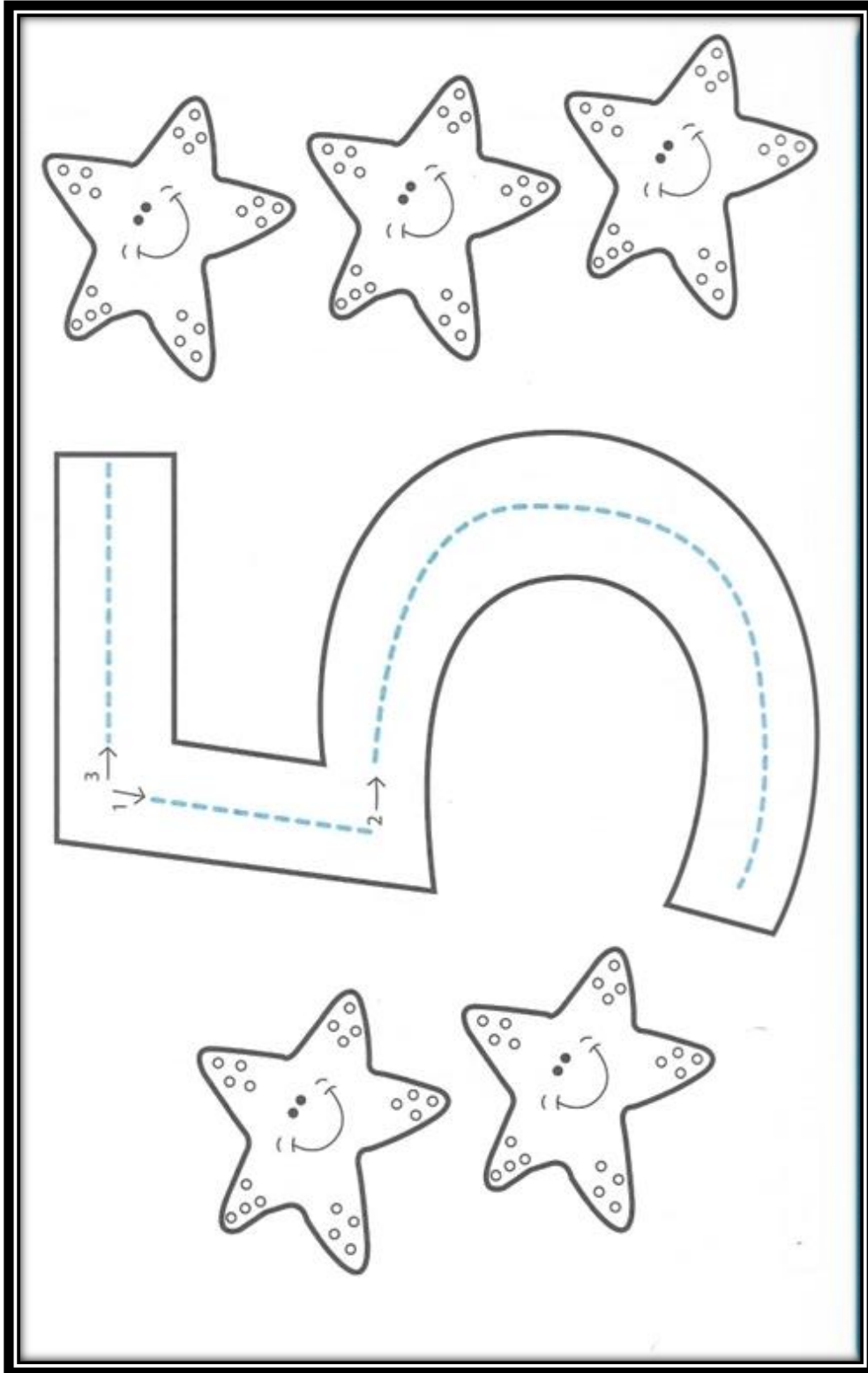

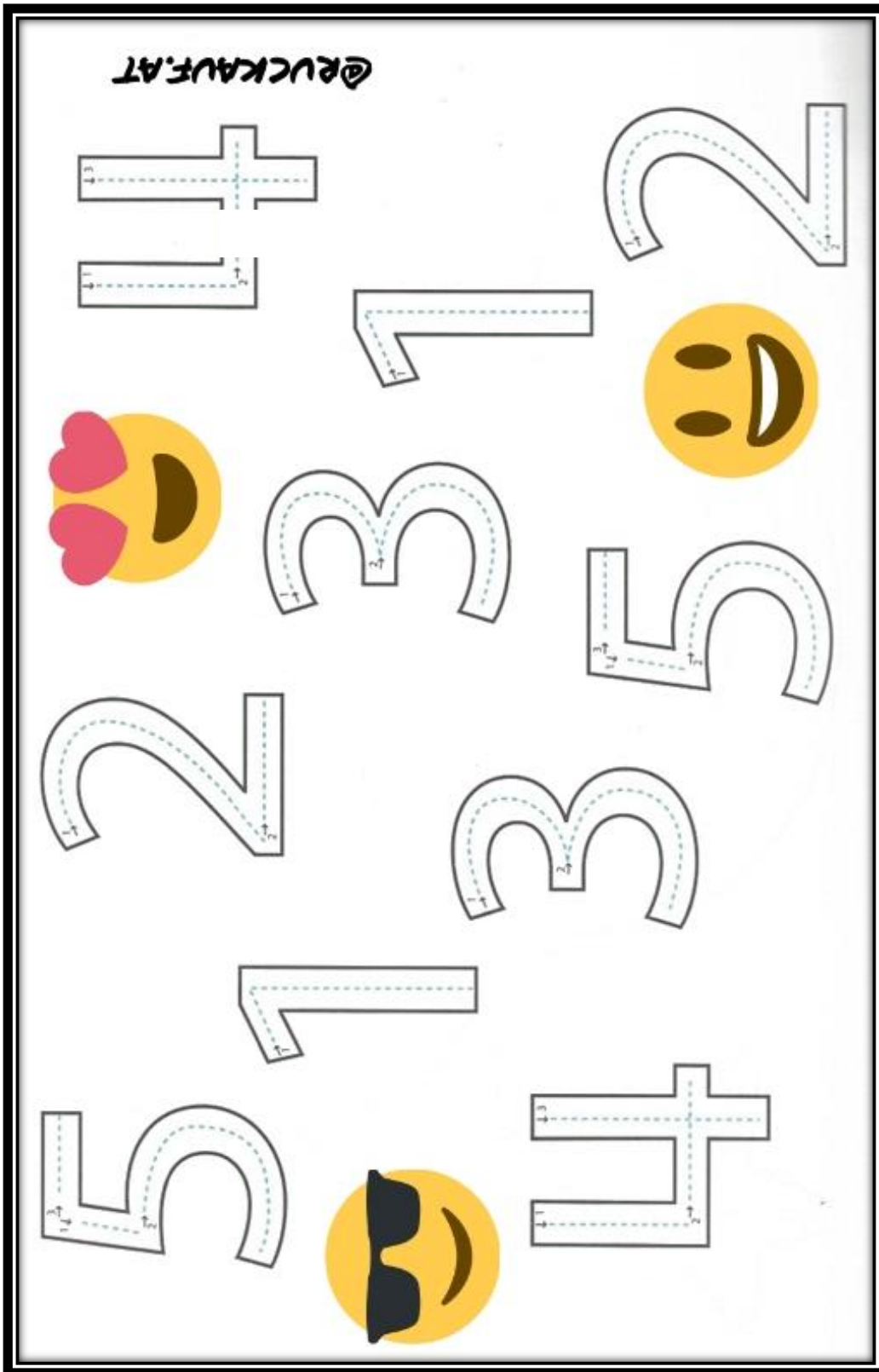

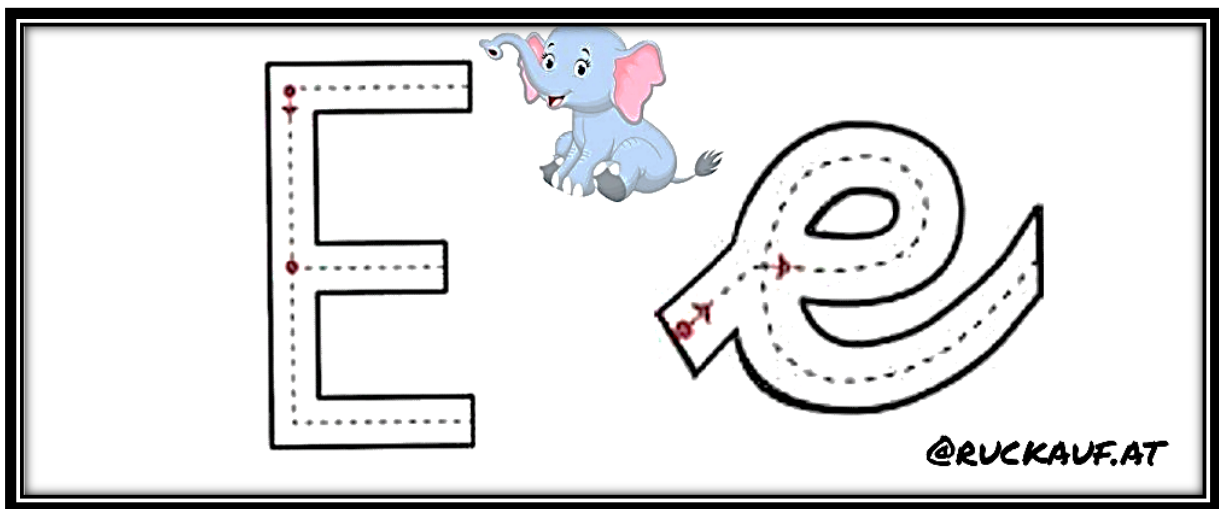
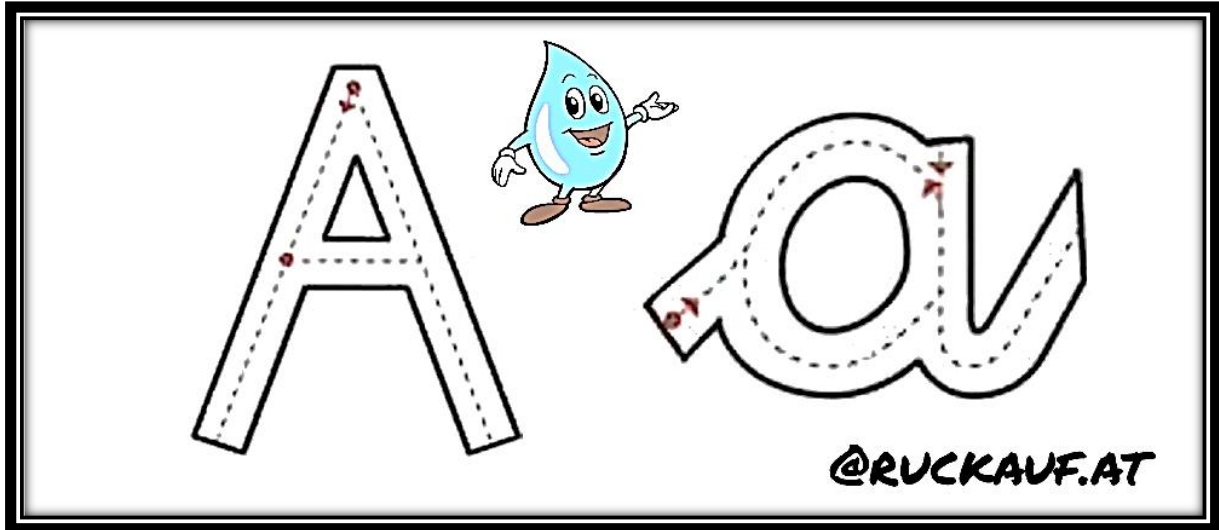

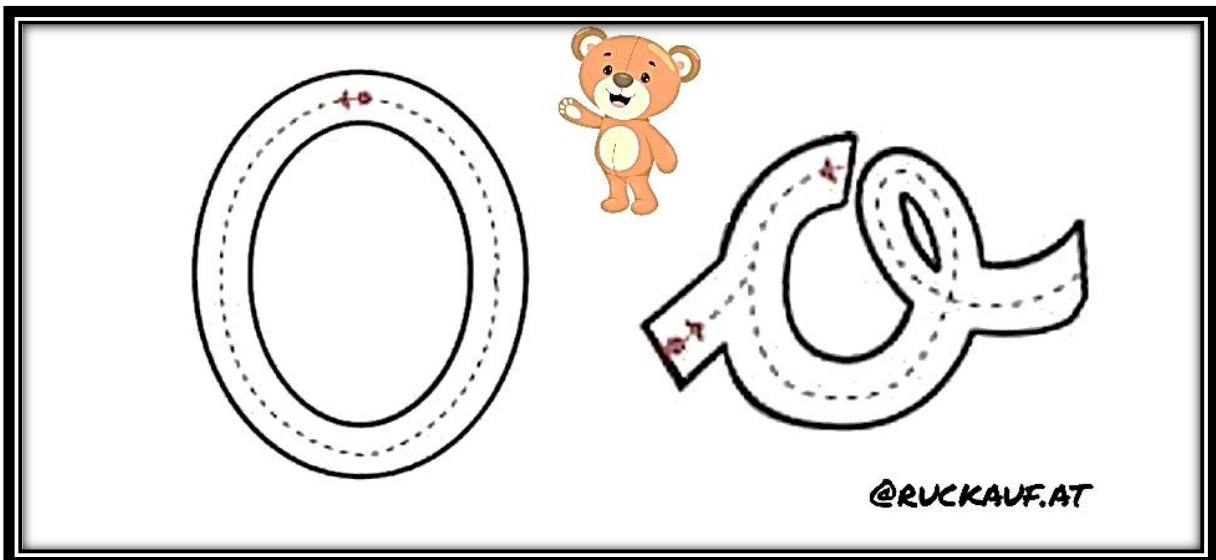
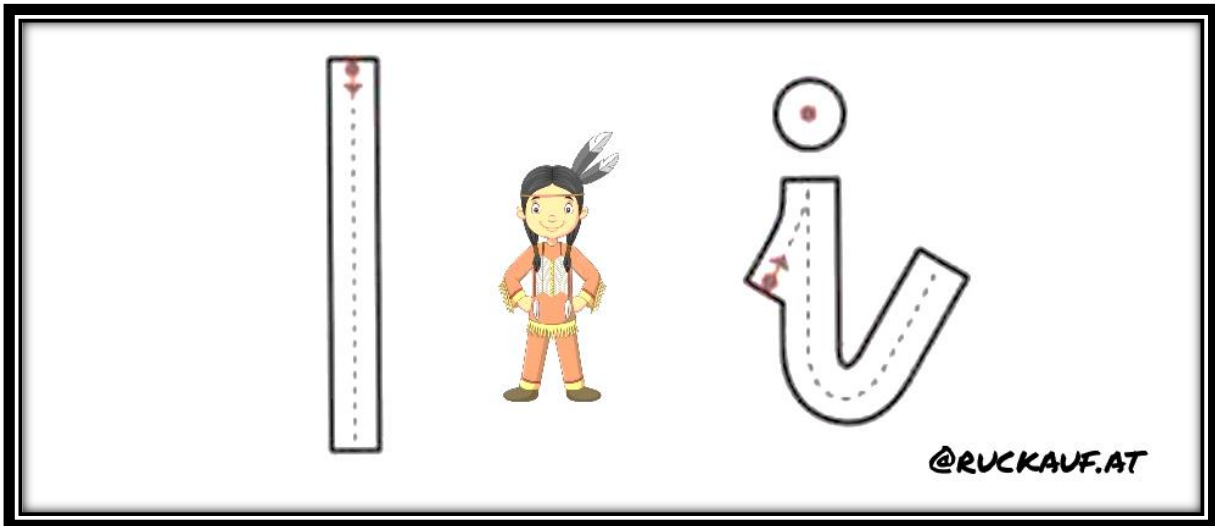

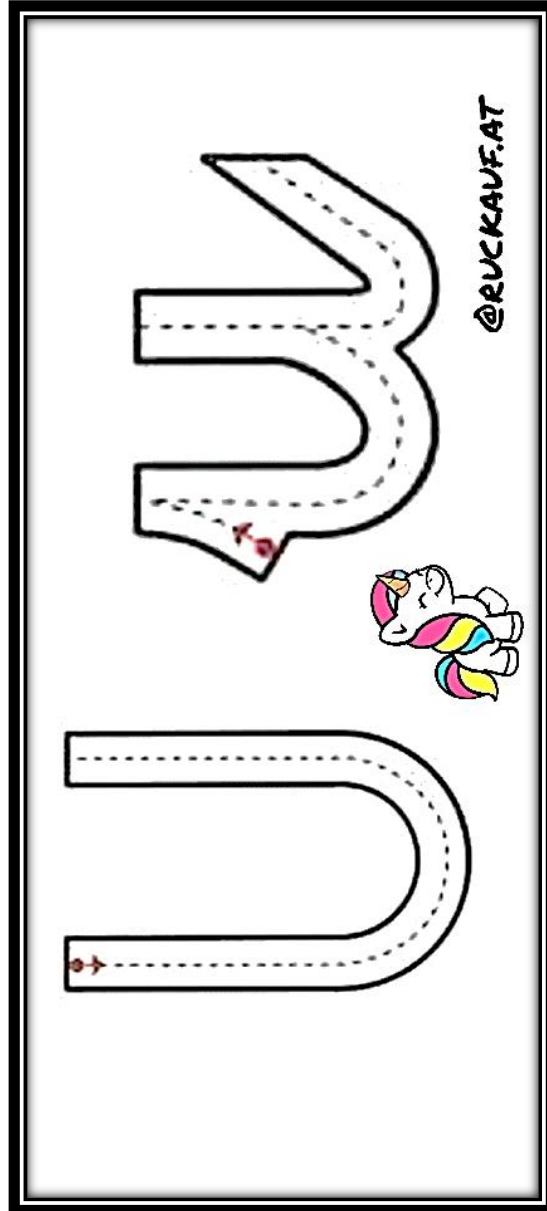

Copiar el modelo

The image shows a large rectangular frame containing a tracing exercise. At the top of the frame, there is a wavy line with a dashed arrow indicating the starting point and direction. Below this are six empty rectangular boxes for copying the wavy line.

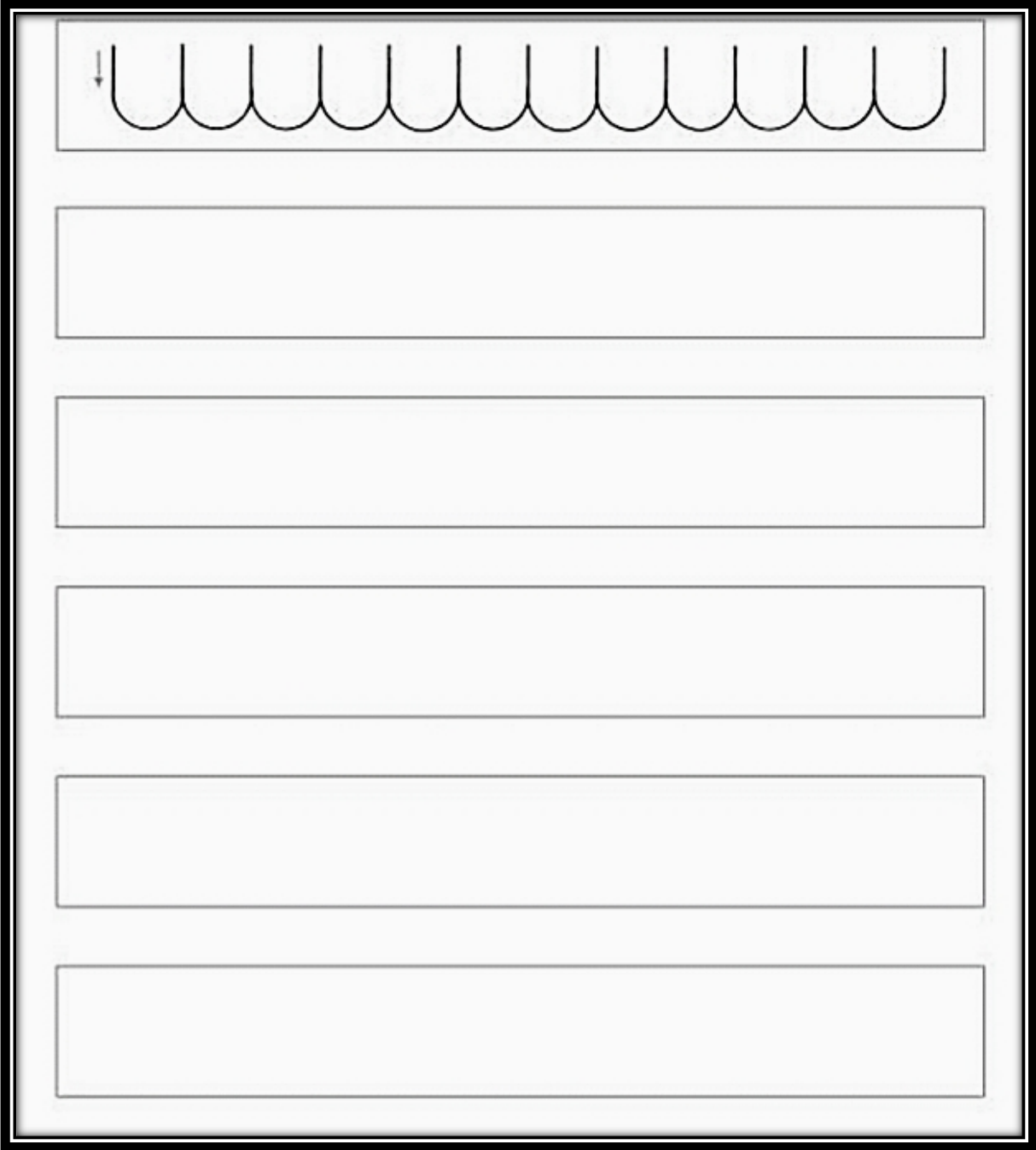

The image shows a handwriting practice sheet. At the top, within a large rectangular frame, is a row of ten connected 'u' shapes. A small downward-pointing arrow is positioned at the start of the first 'u' to indicate the starting point and direction of the stroke. Below this row are five more identical rows, each empty for the user to practice the tracing exercise.

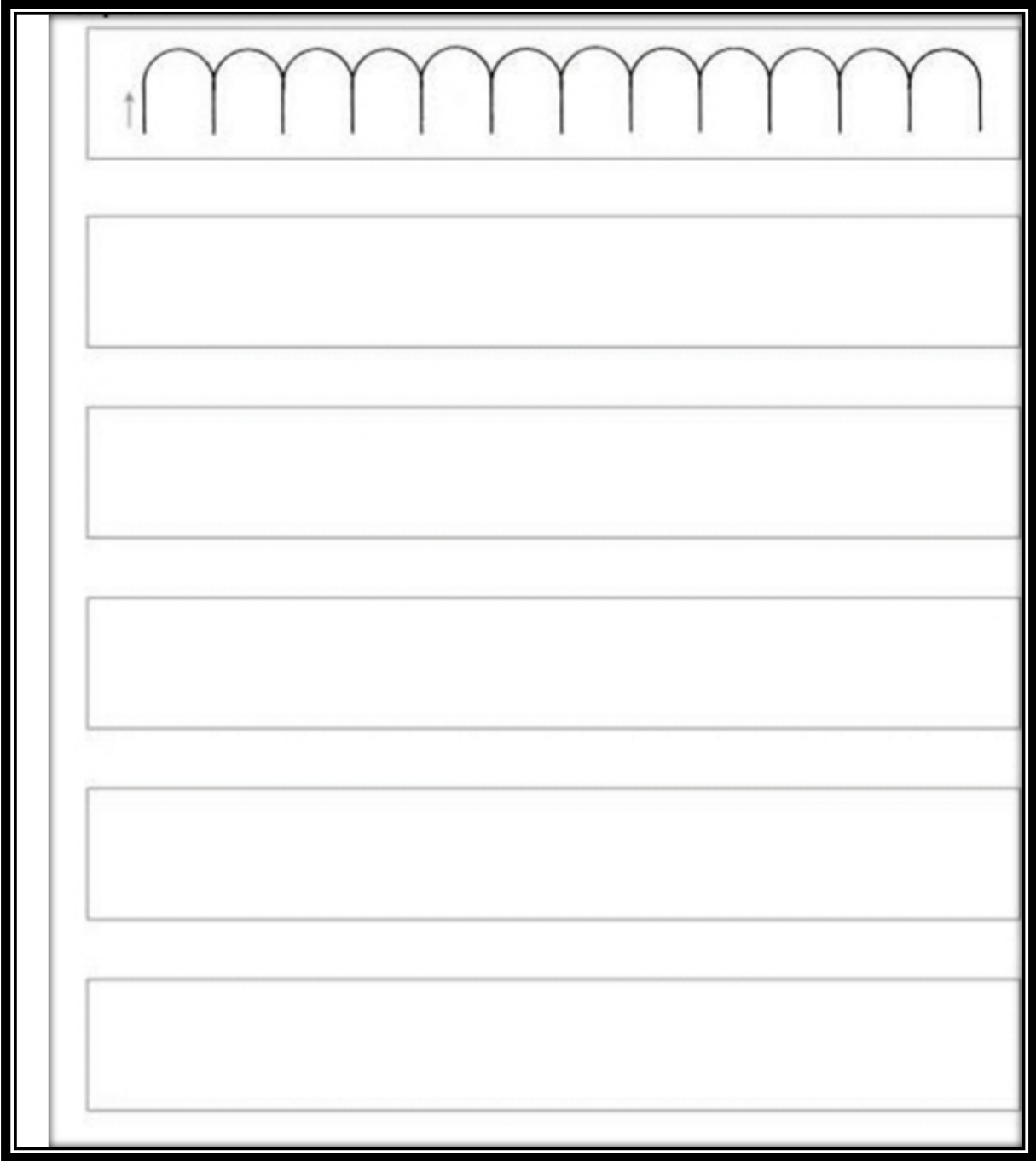

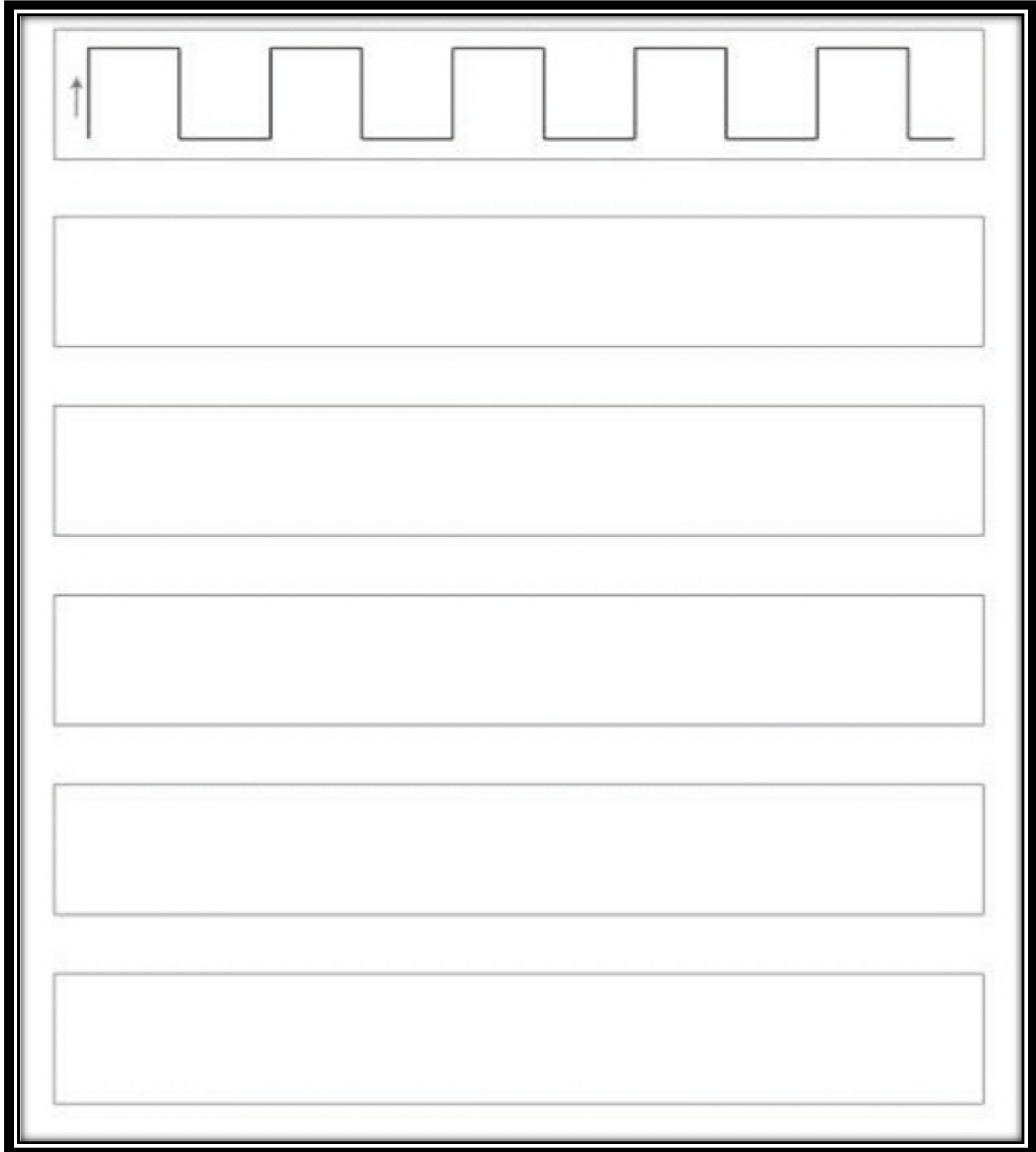

This section contains a tracing exercise. At the top, there is a square wave pattern with an upward-pointing arrow on the left side. Below this pattern are five empty rectangular boxes for practice.

The image shows a large rectangular frame containing a tracing exercise. At the top, there is a horizontal line with eight overlapping loops, starting from the left with a small arrow pointing right. Below this line are six empty rectangular boxes, each the same size as the first one, intended for practicing the tracing exercise.

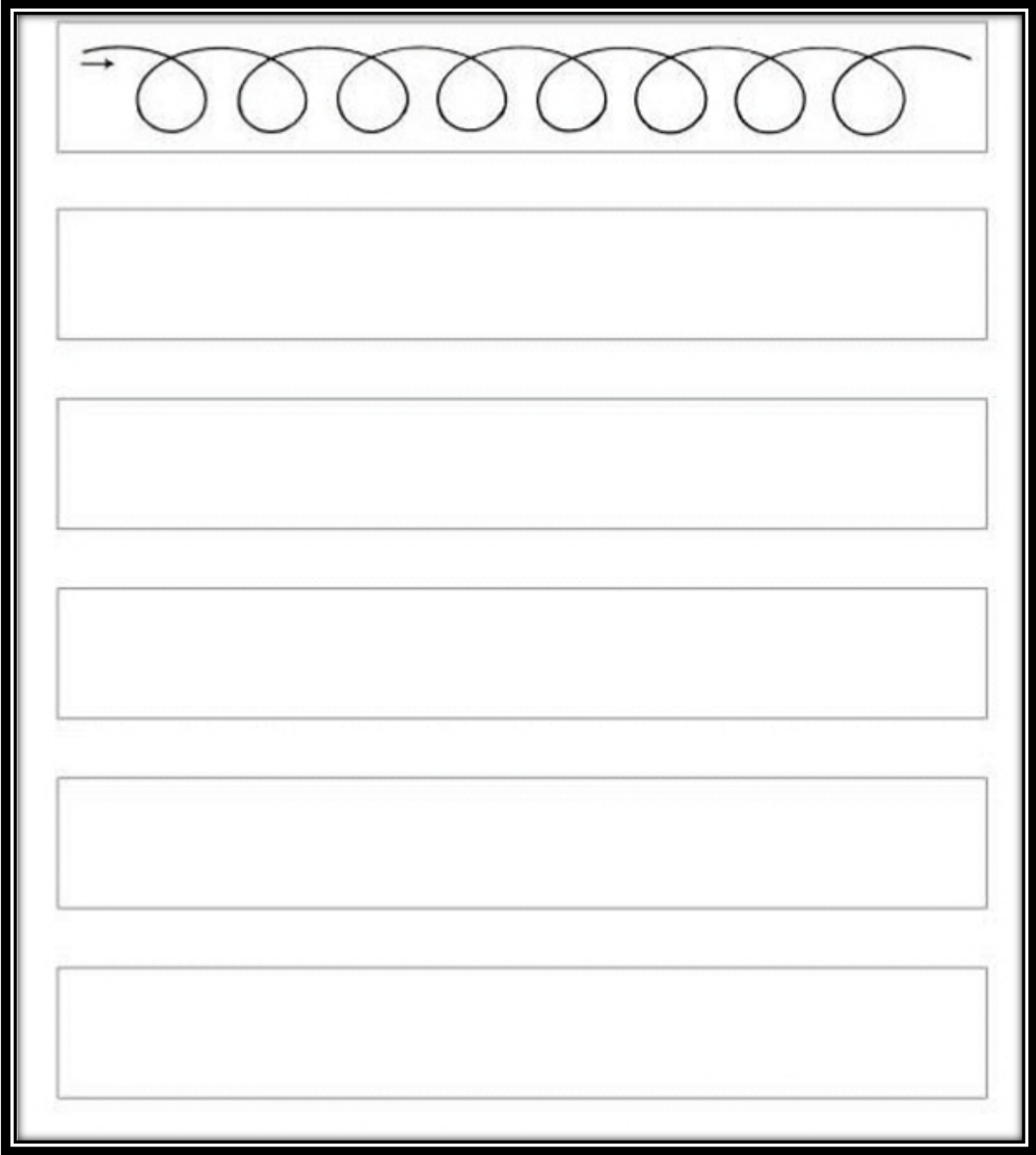

The image shows a large rectangular frame with a double border. Inside the frame, at the top, is a tracing exercise consisting of a continuous line forming eight overlapping circles. An arrow on the left points to the start of the line. Below this tracing exercise are six empty rectangular boxes, one below the other, intended for independent practice of the tracing task.

Continuar el modelo

The image shows a large rectangular box with a double border. Inside, there are five horizontal rows. The top row contains a continuous wave pattern starting with a downward-pointing arrow on the left. The wave moves down, then up, then down, then up, and finally down. The rest of the box is divided into four identical empty rows, each containing vertical lines that define the grid for the wave pattern.

A large rectangular frame containing five horizontal rows for handwriting practice. The top row features a model of the letter 'm' on the left, with a small upward-pointing arrow indicating the starting stroke. To the right of the model are ten vertical lines. The following four rows each contain ten vertical lines, providing a guide for the letter's width and placement.

The image shows a handwriting practice sheet within a large black border. It consists of five horizontal rows, each containing 15 vertical lines. The top row is pre-filled with a wavy line that starts with a downward-pointing arrow on the left, indicating the direction of the stroke. The remaining four rows are empty, providing space for independent practice of the wavy line pattern.









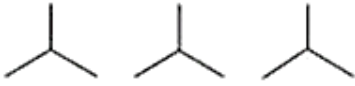
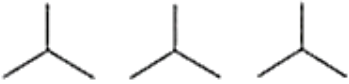
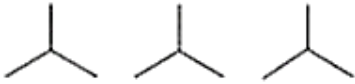
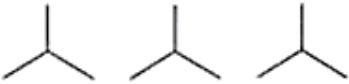
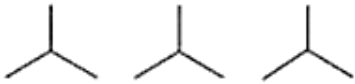
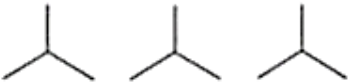
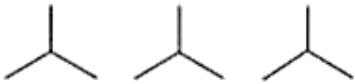
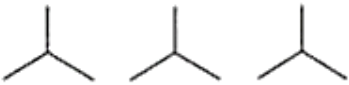
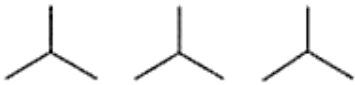

The image shows a handwriting practice sheet within a large black border. It consists of five horizontal rows. The top row is pre-filled with three connected arches on the left side, with a small upward-pointing arrow to the left of the first arch. To the right of these arches are 15 vertical lines. The four rows below are empty, each containing 15 vertical lines for tracing or independent practice.











The image shows a handwriting practice sheet within a large black border. It consists of five horizontal rows. The top row contains three loops, each with a central dot and an arrow pointing downwards and to the left, indicating the stroke direction. To the right of these loops are seven individual dots. The four rows below each contain nine individual dots, spaced evenly across the row.

The image shows a large rectangular frame containing five horizontal rows. The top row features three connected loops, each with a central dot and an arrow pointing to the right, indicating a path. To the right of these loops are seven individual dots. The four rows below each contain seven individual dots, providing a space for practice or completion of the exercise.

Copiando más modelos

	
	
	
	
	

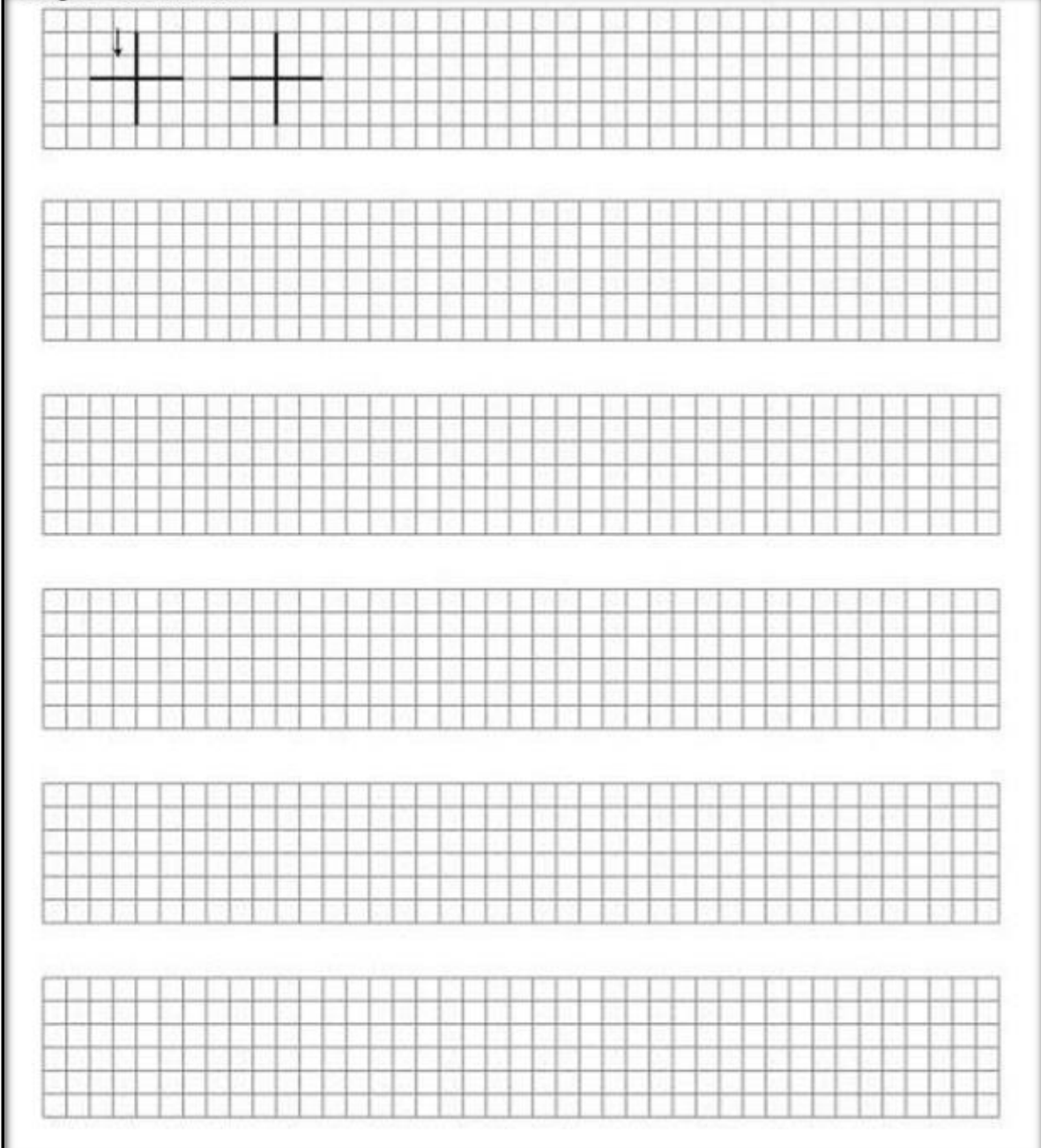

A large grid for handwriting practice, containing six horizontal rows. The first row shows a cross with a downward arrow on its vertical stem, followed by a second cross. The remaining five rows are empty.

The image shows a large rectangular area with a grid pattern, enclosed in a double-line border. At the top left of this area, there are two diamond shapes (rhombuses) drawn on the grid. Each diamond is formed by four lines connecting the midpoints of the grid's sides. Inside each diamond, there is a cross formed by two lines connecting opposite corners. The first diamond has a small arrow pointing to its top-left corner. Below these two diamonds are six empty rows of the same grid pattern, intended for copying or practicing the drawing.

Espejo

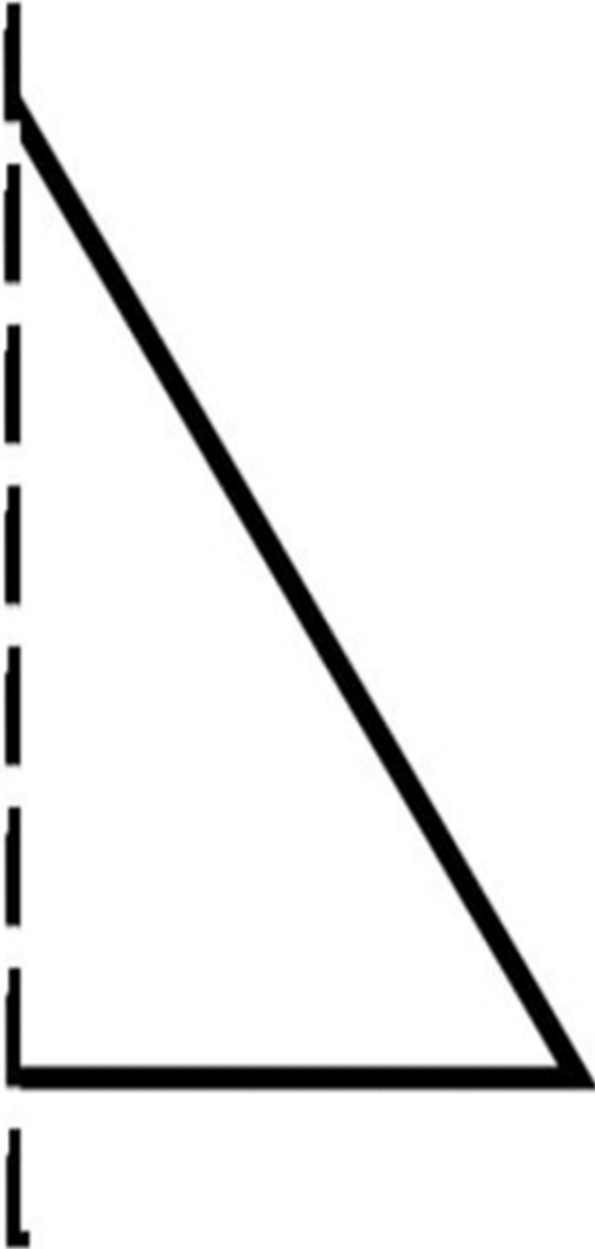

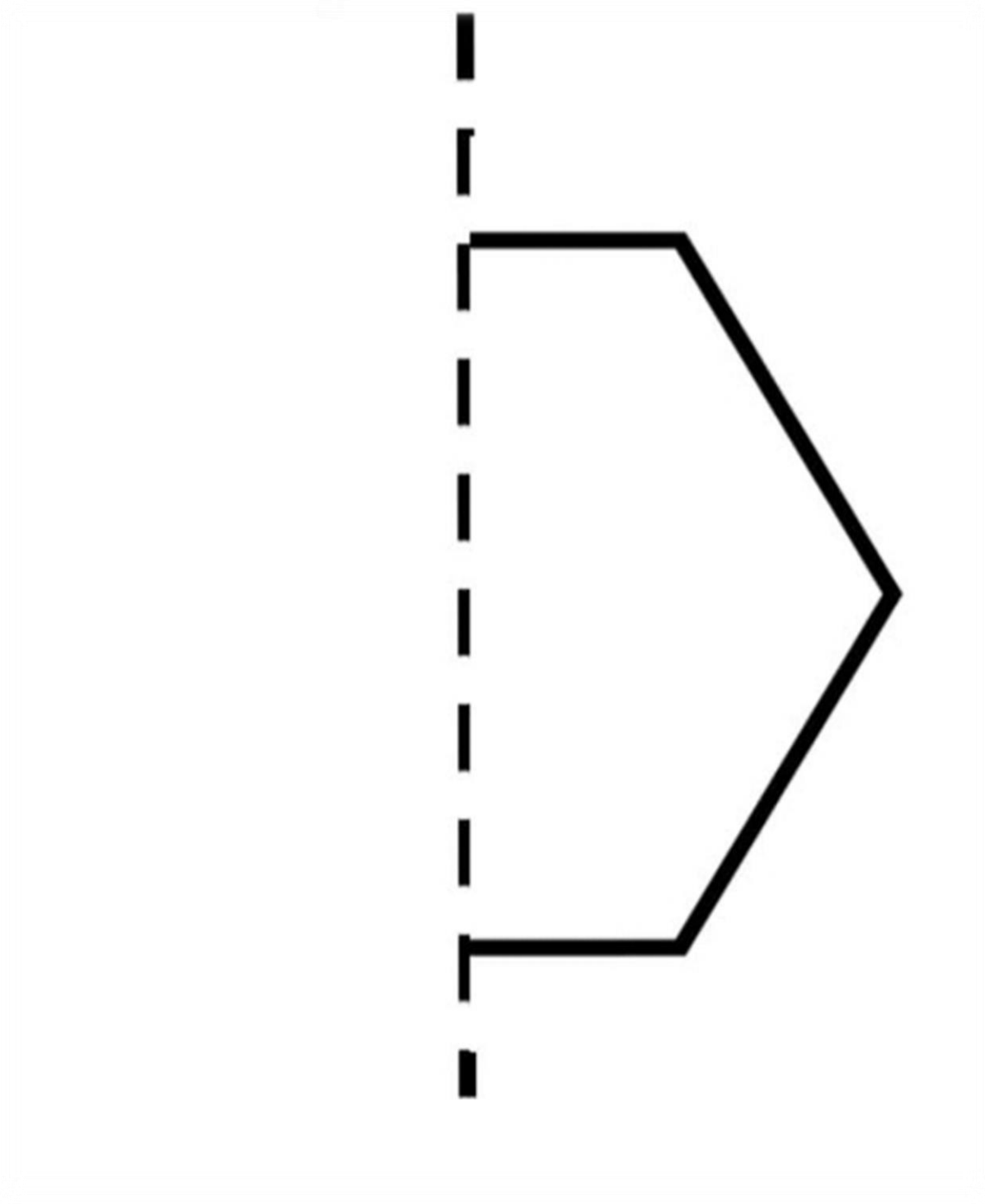

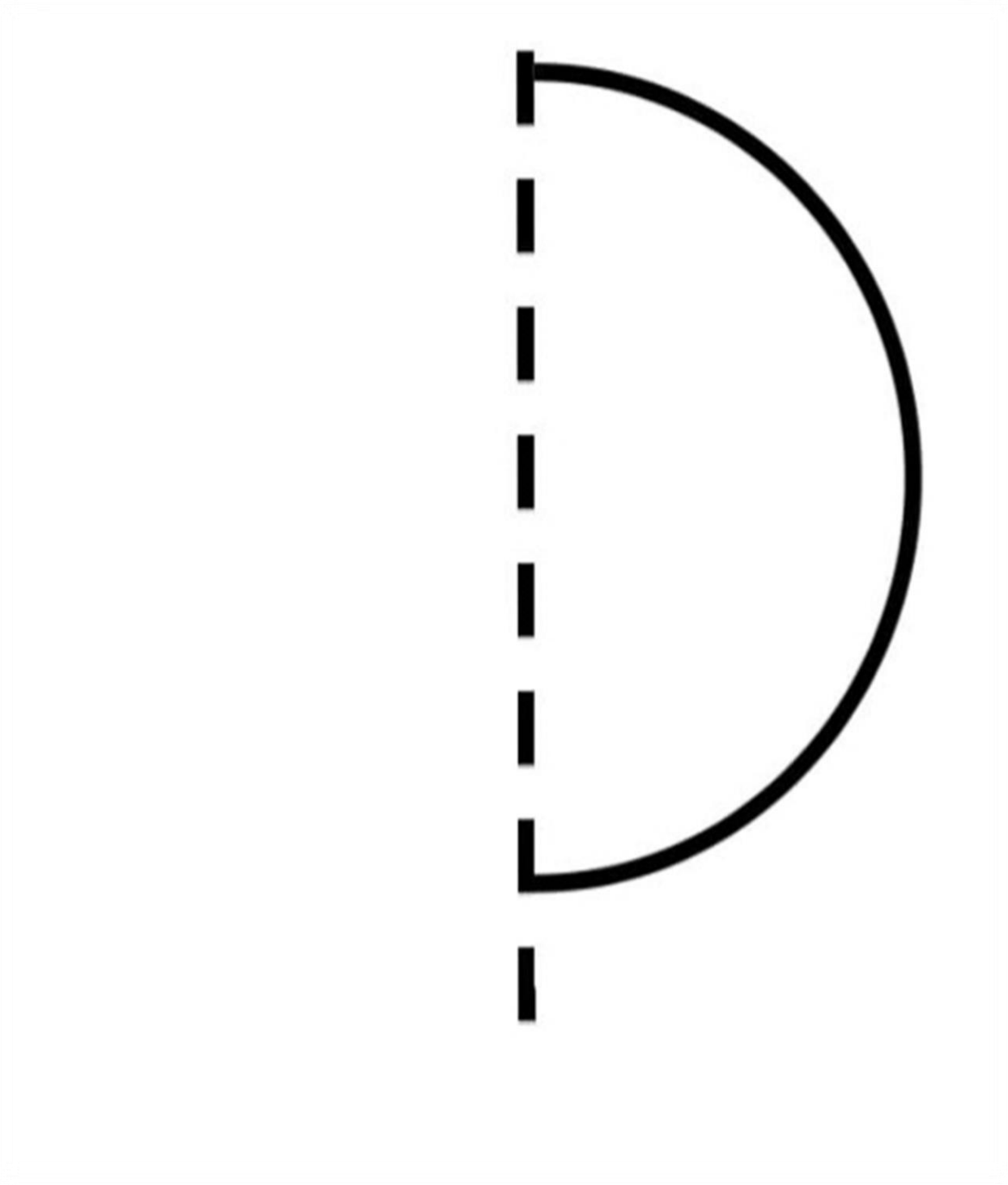

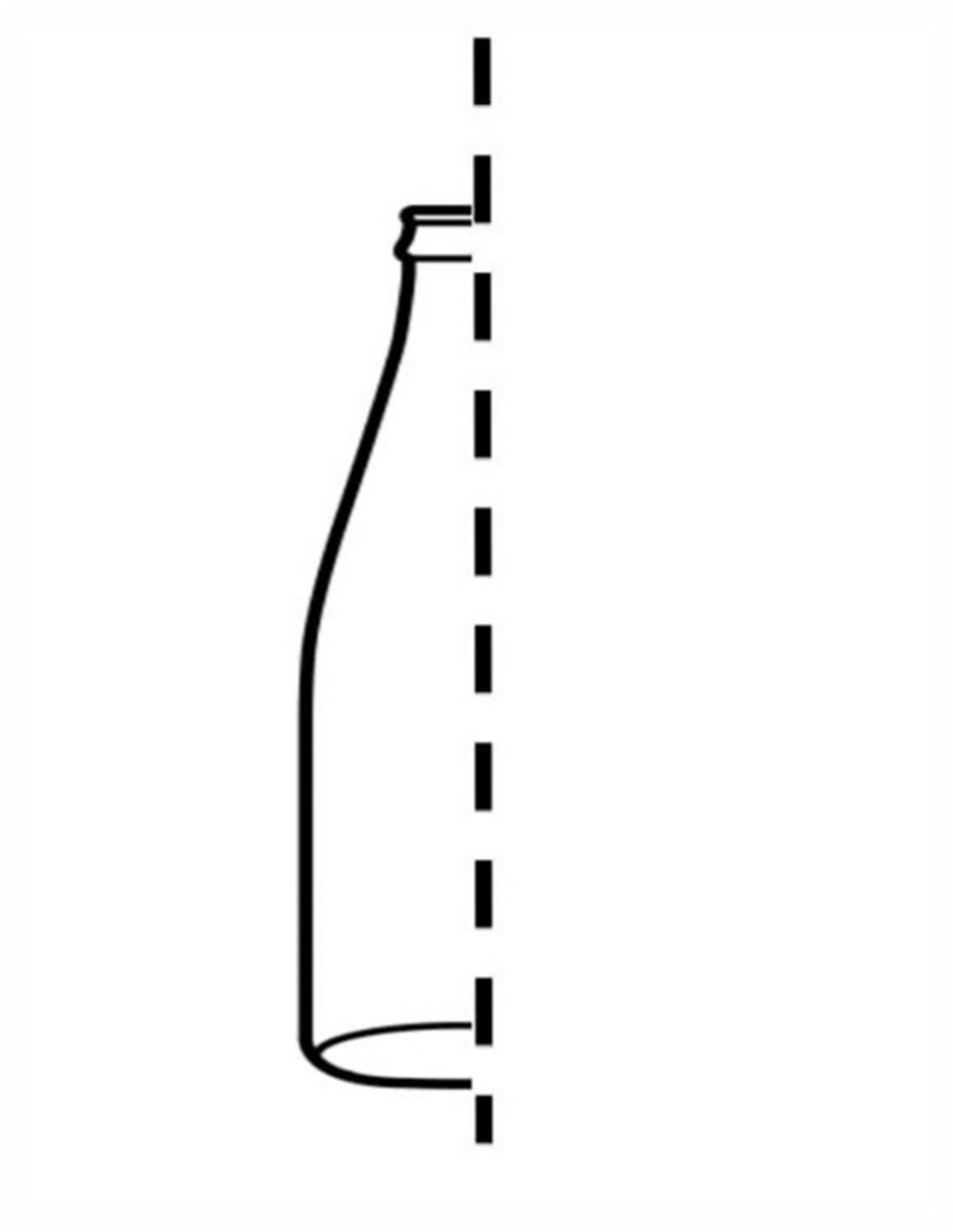

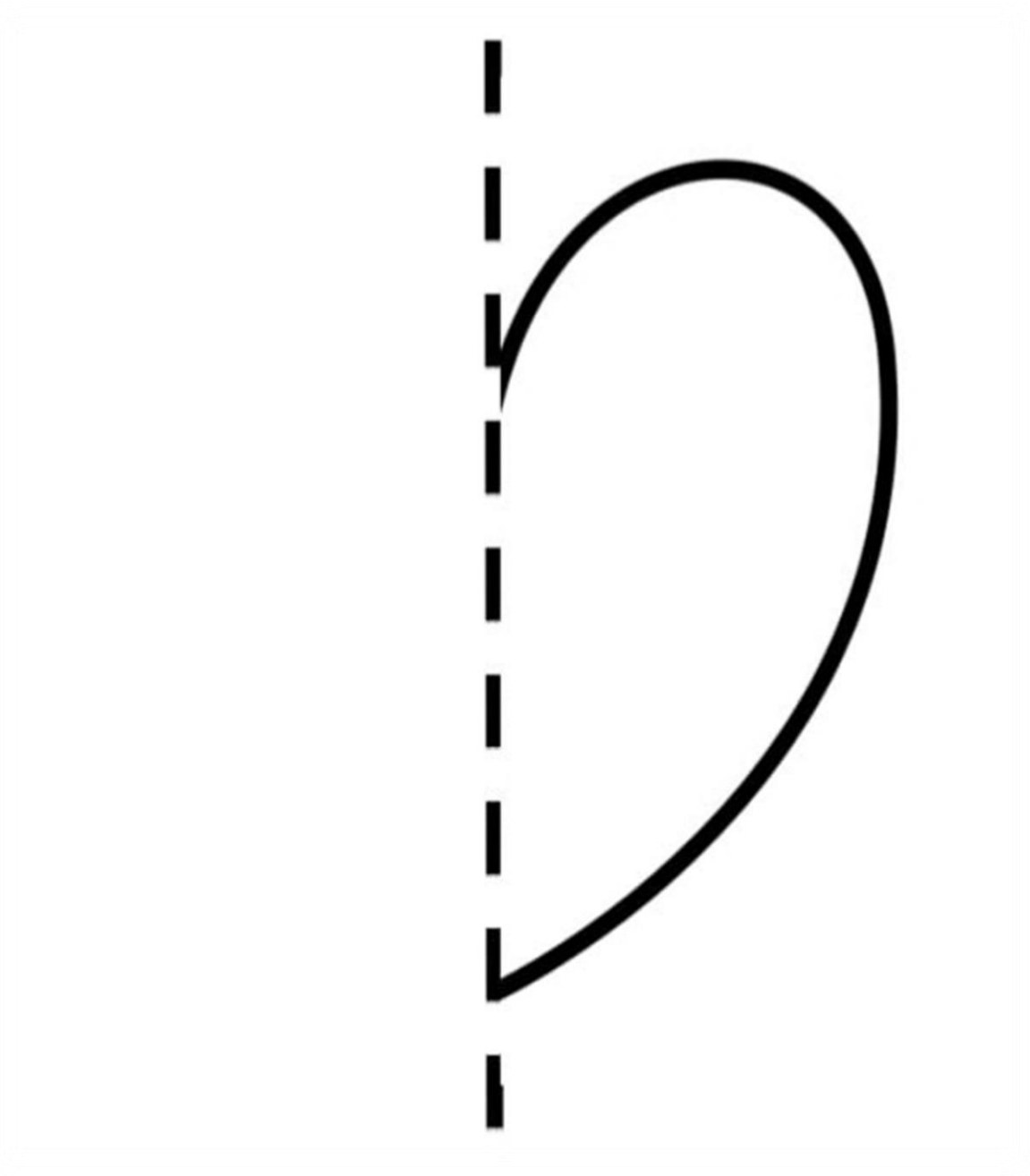



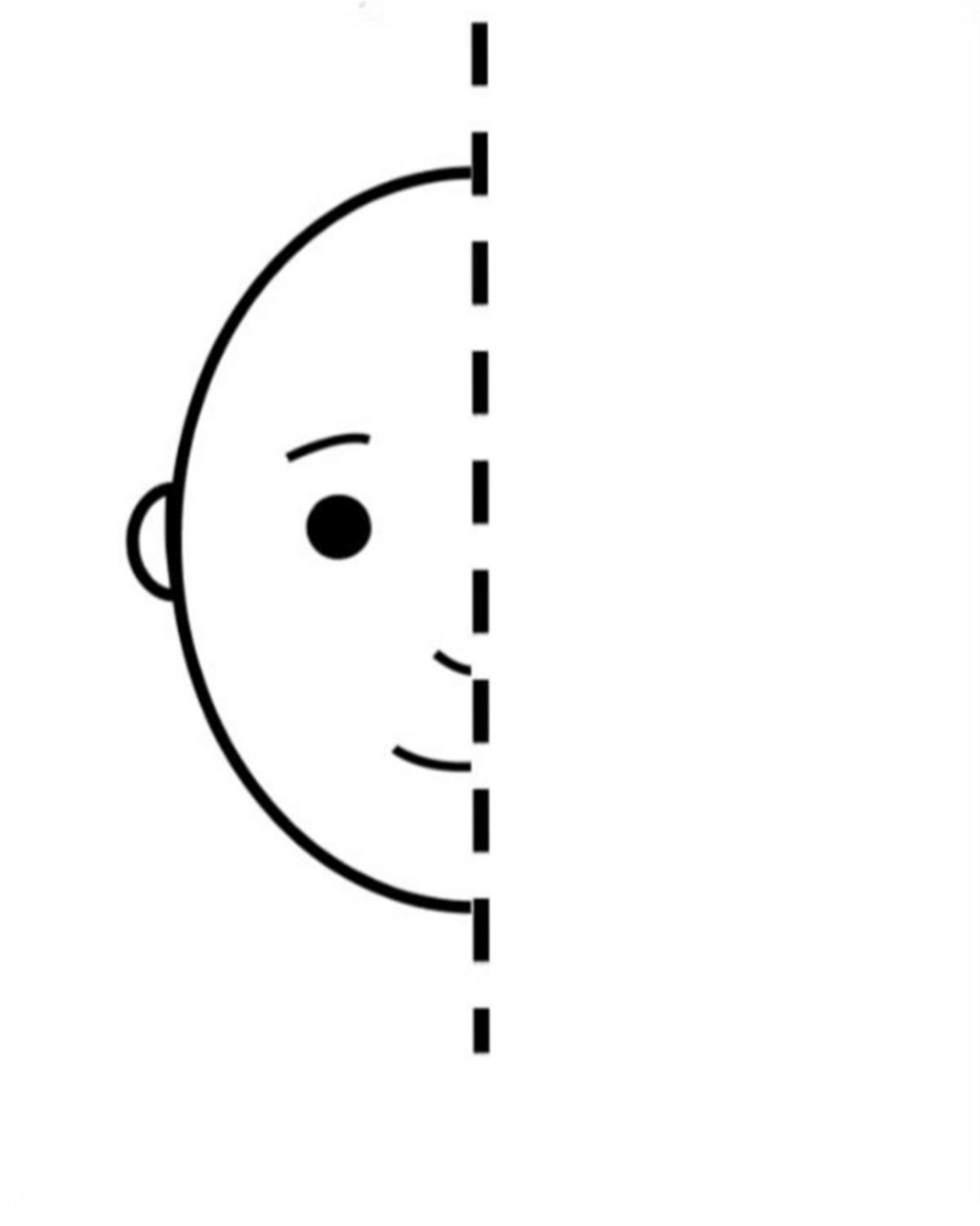



Para pintar





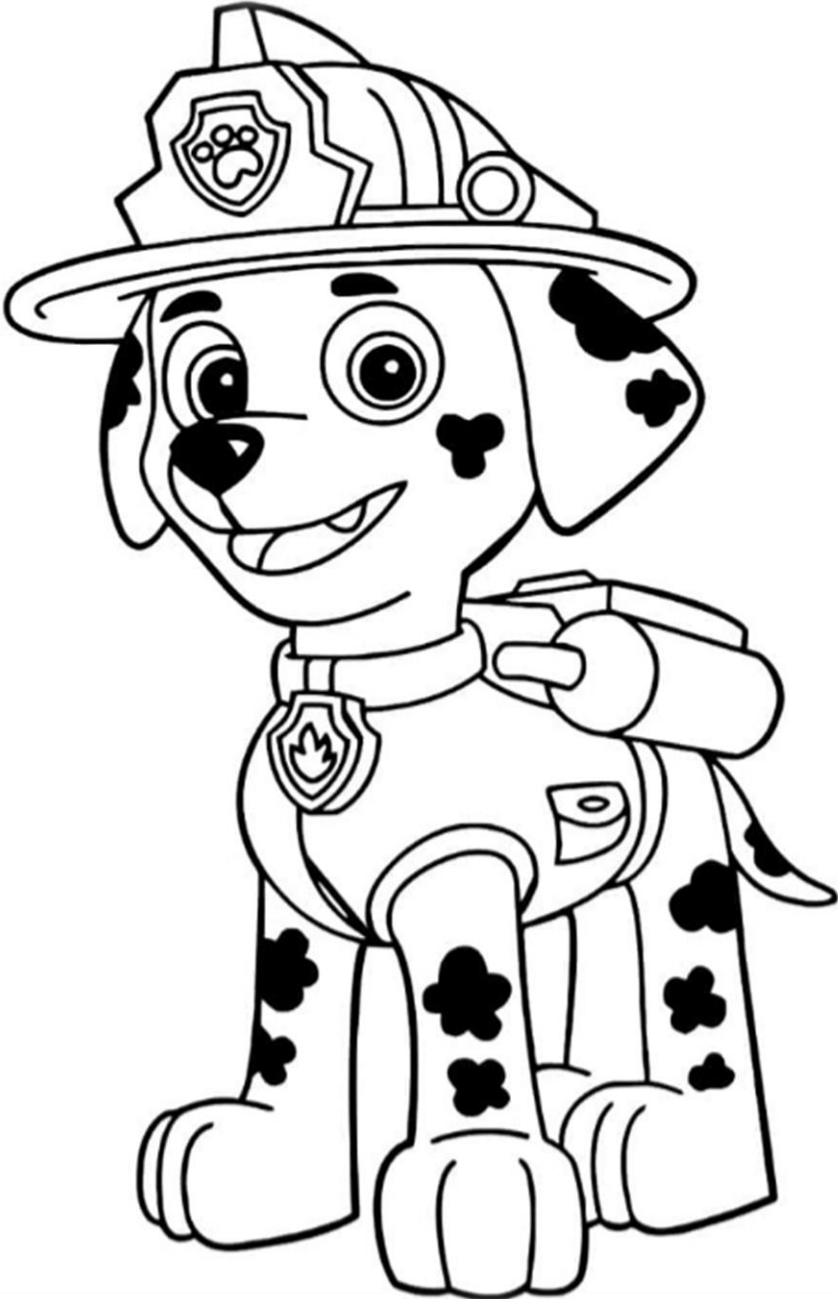



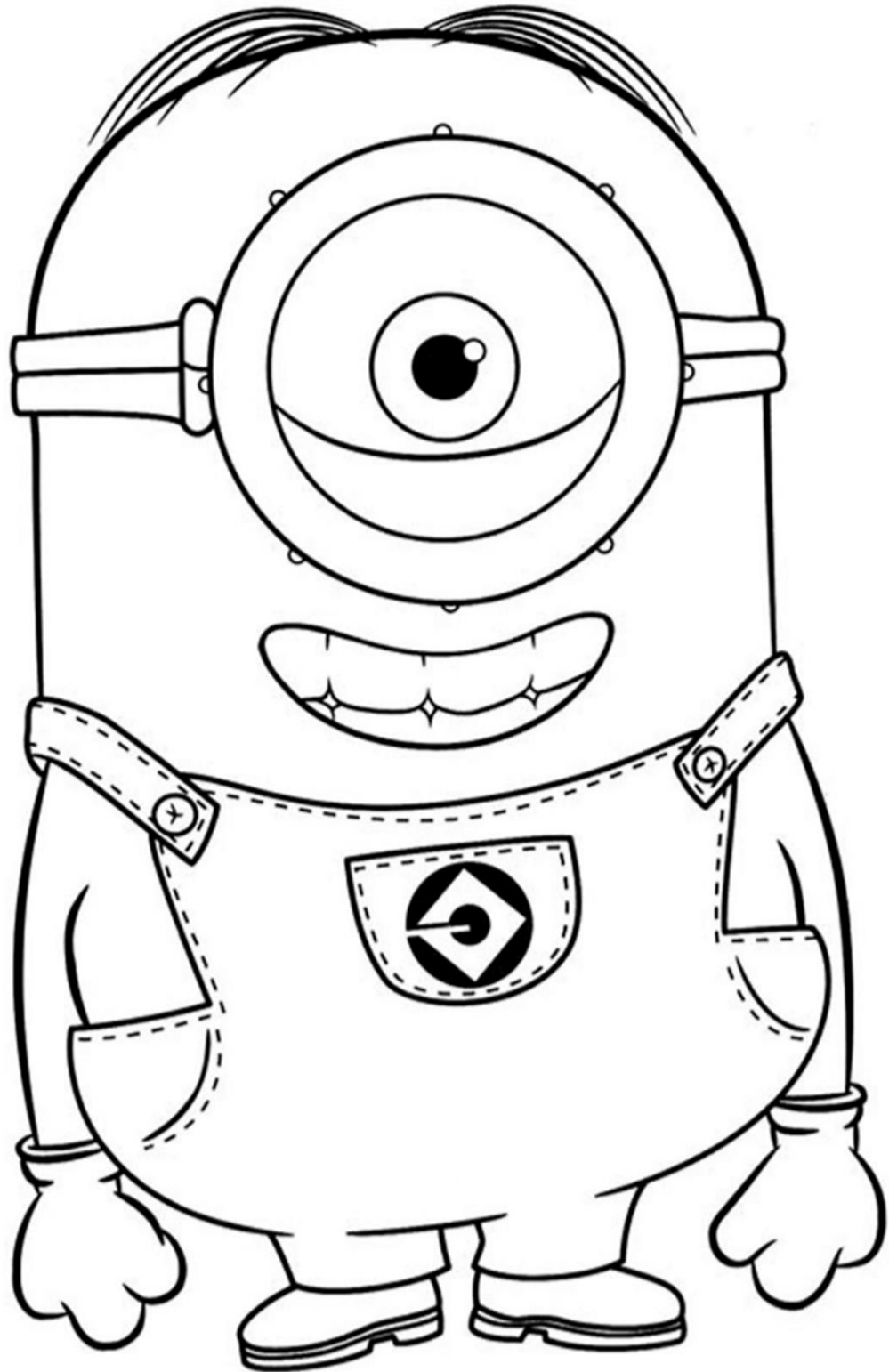

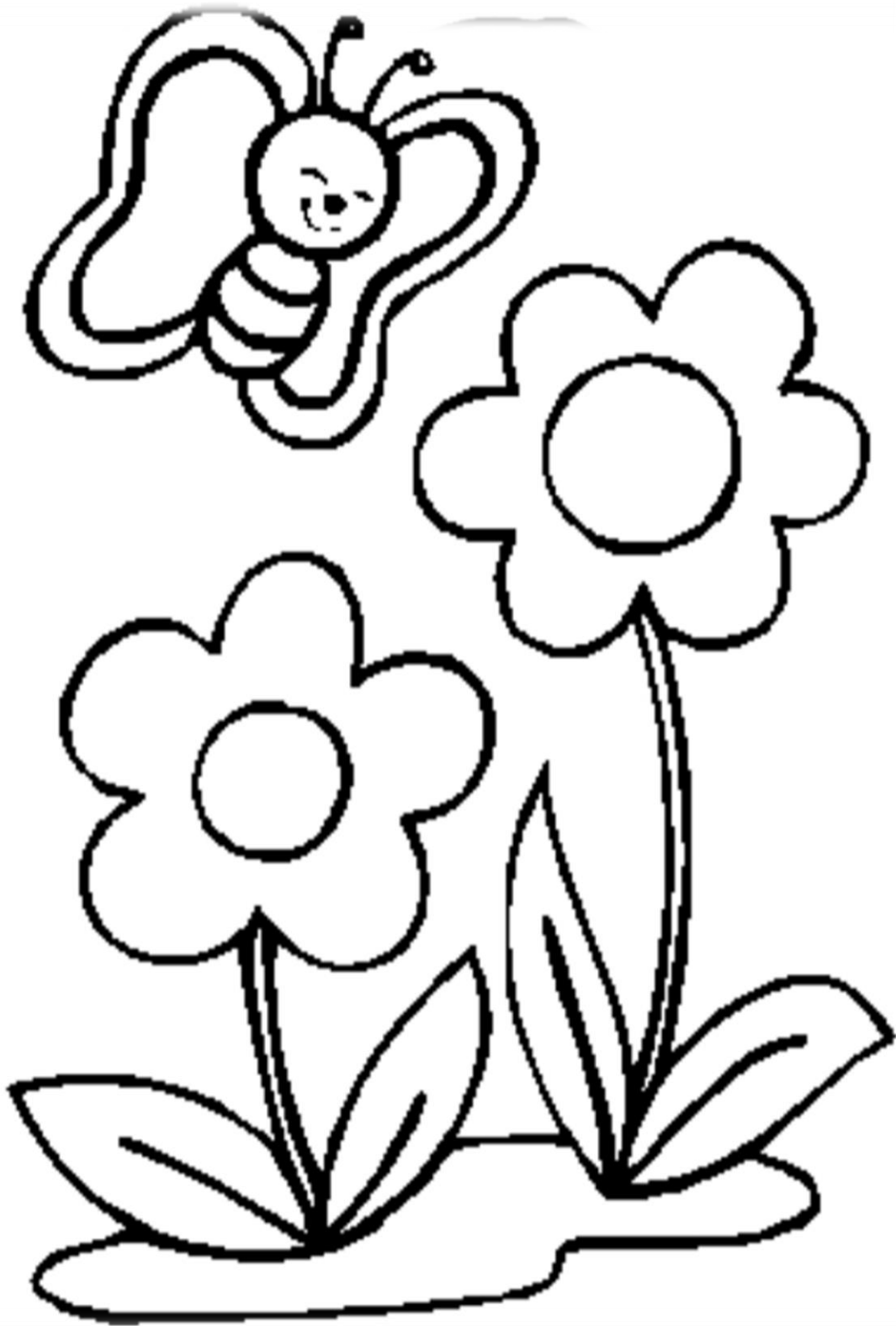





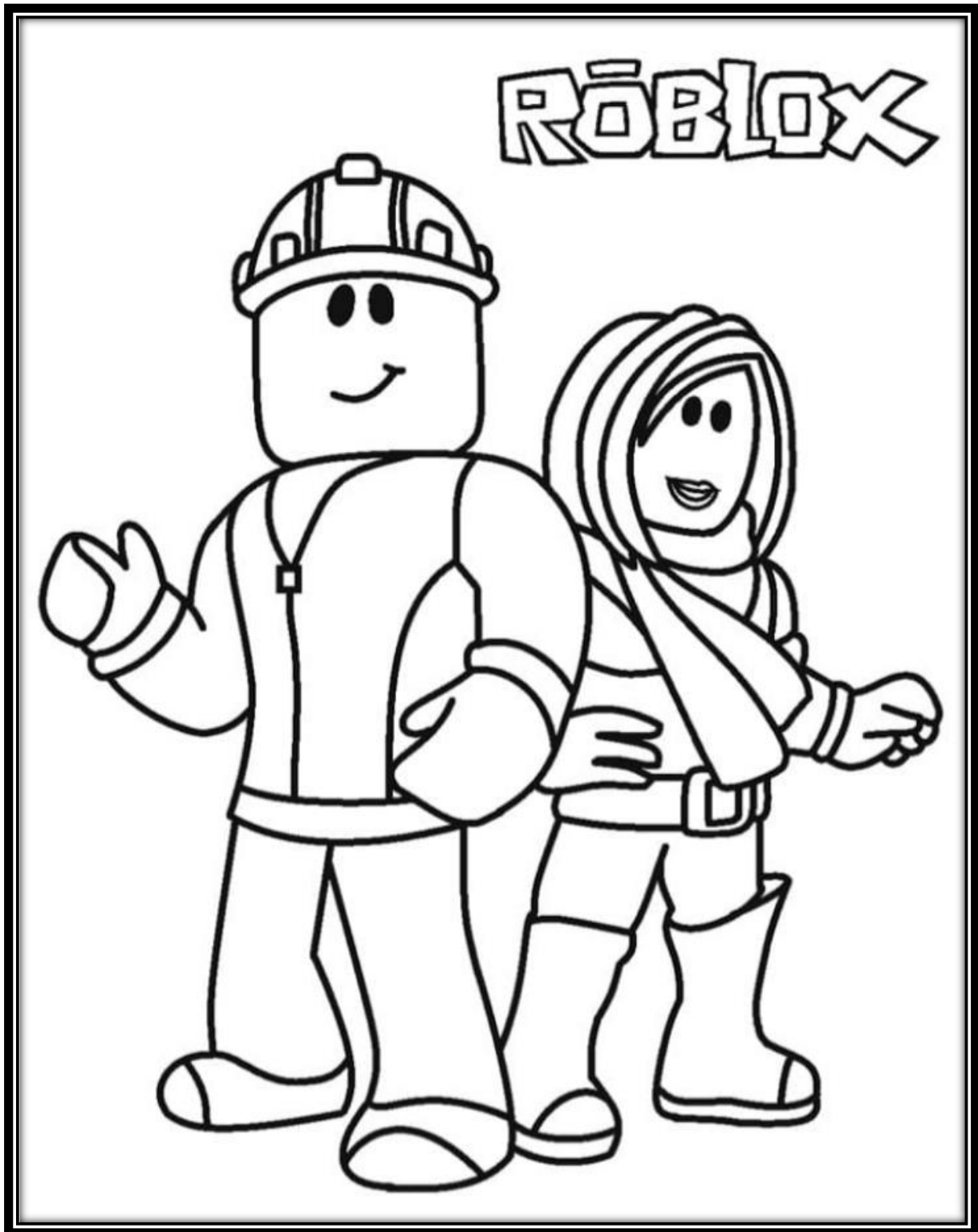

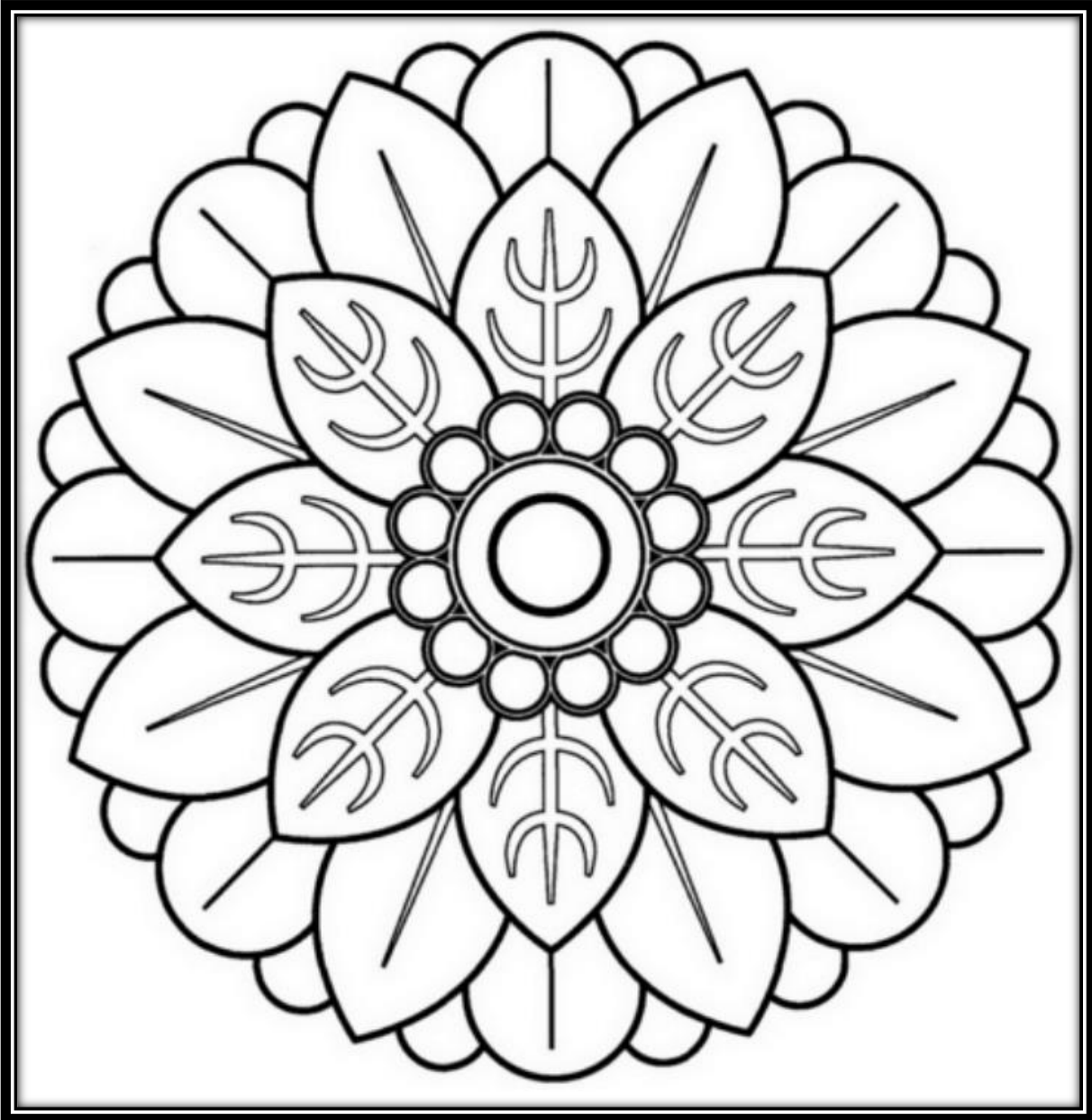

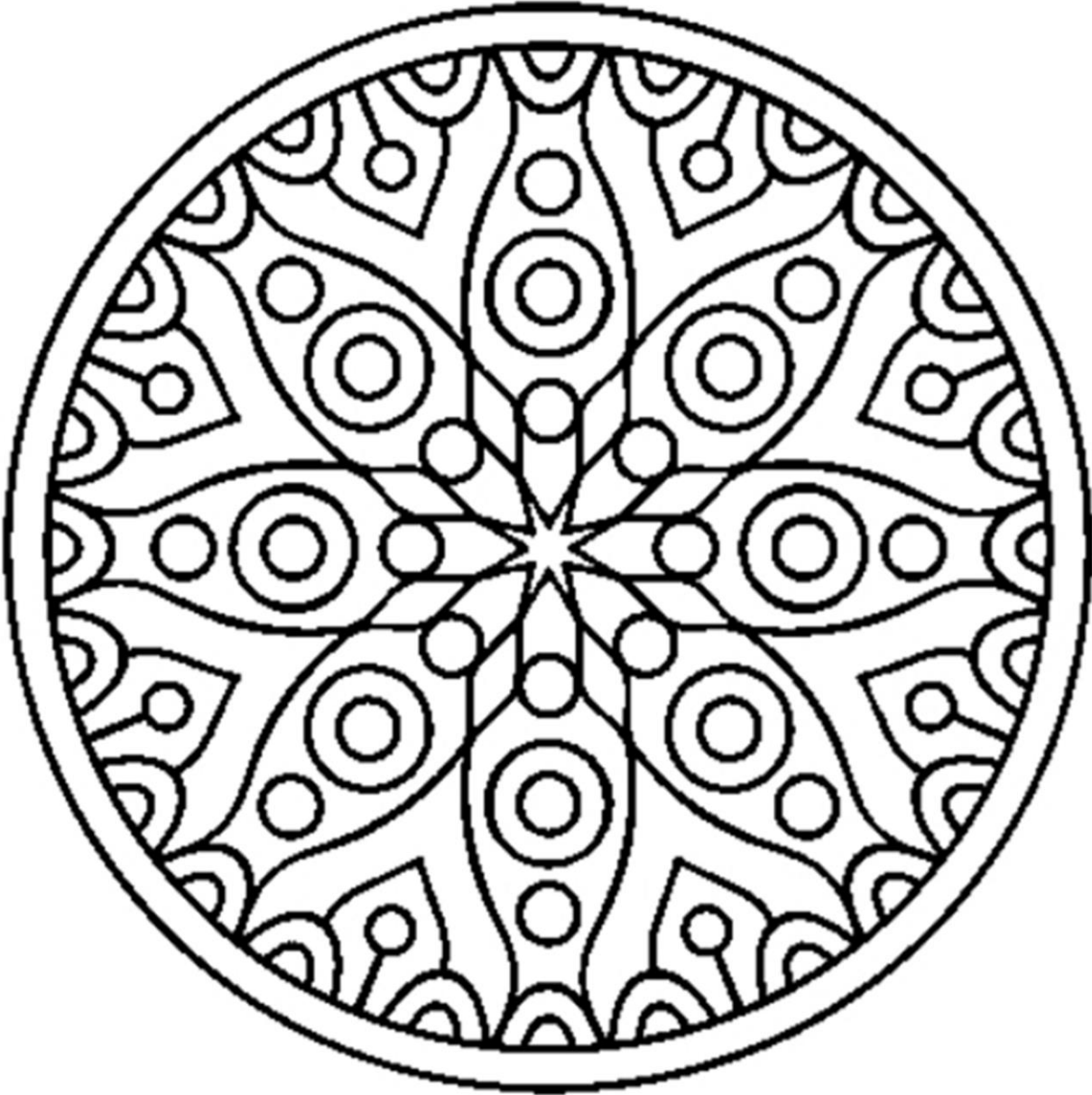

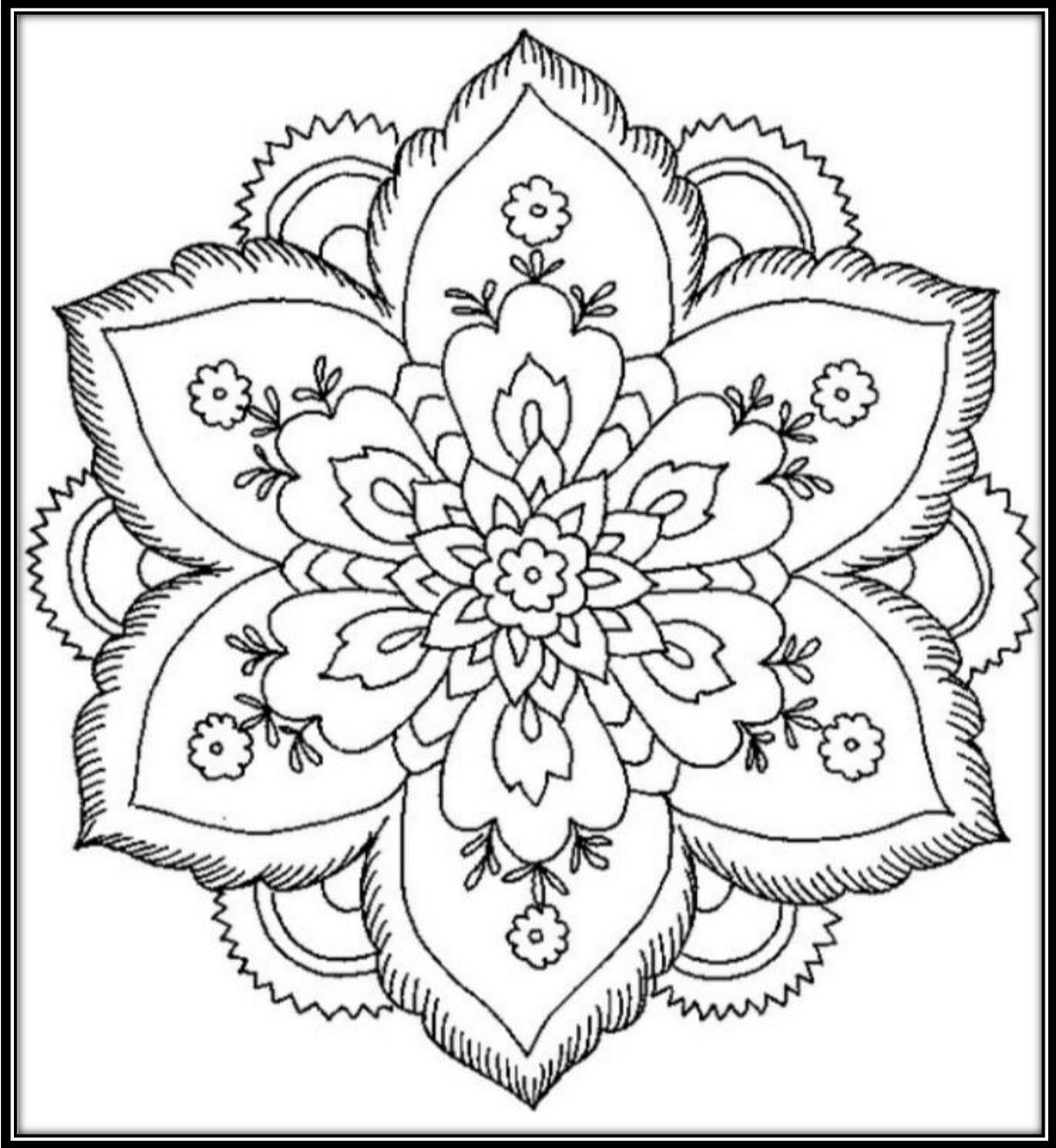

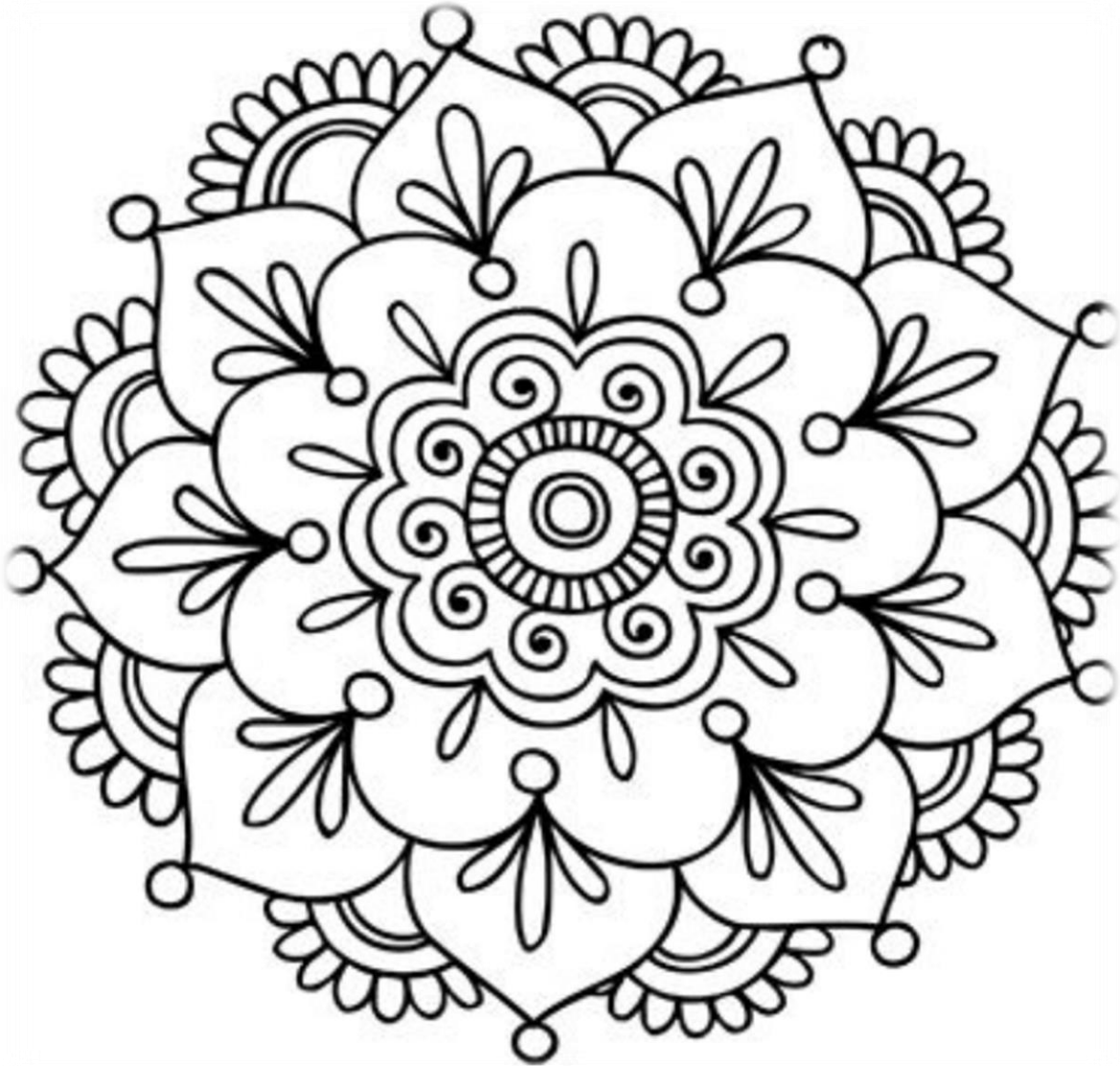

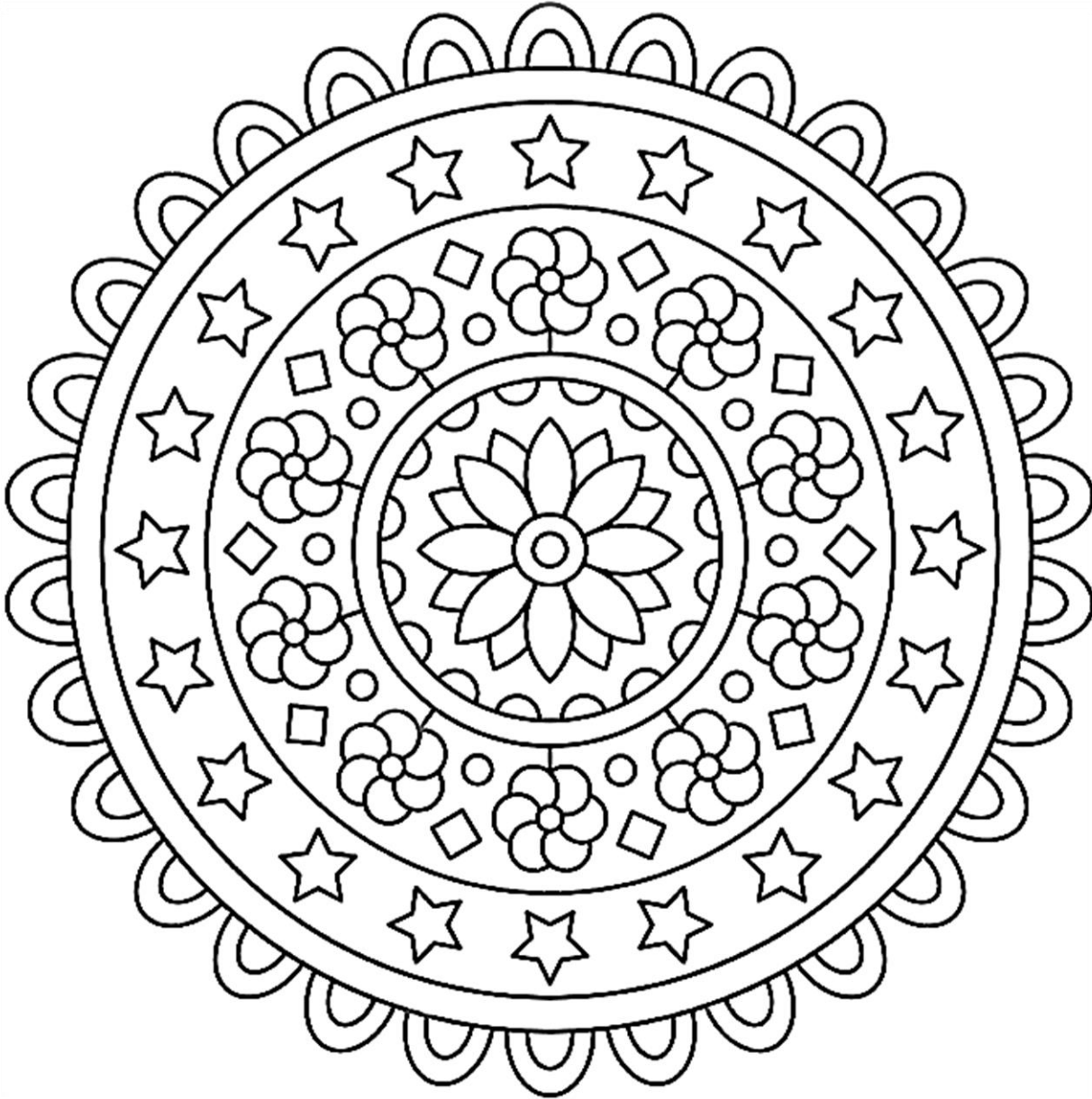

Viso-construcción

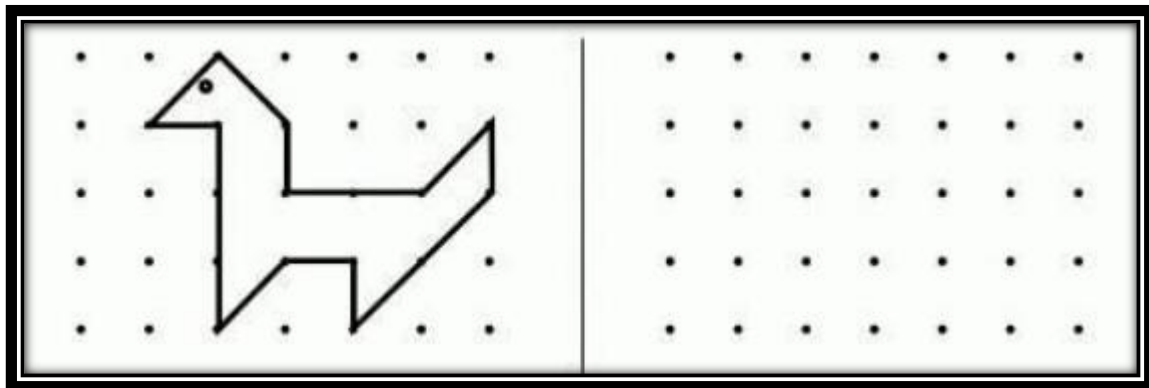
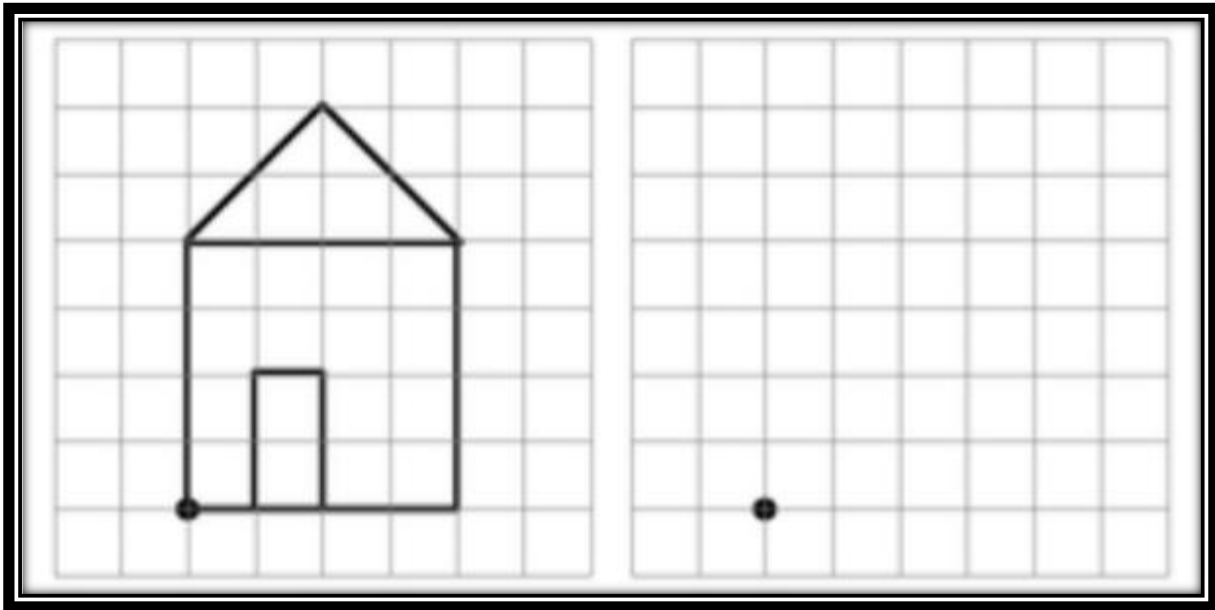

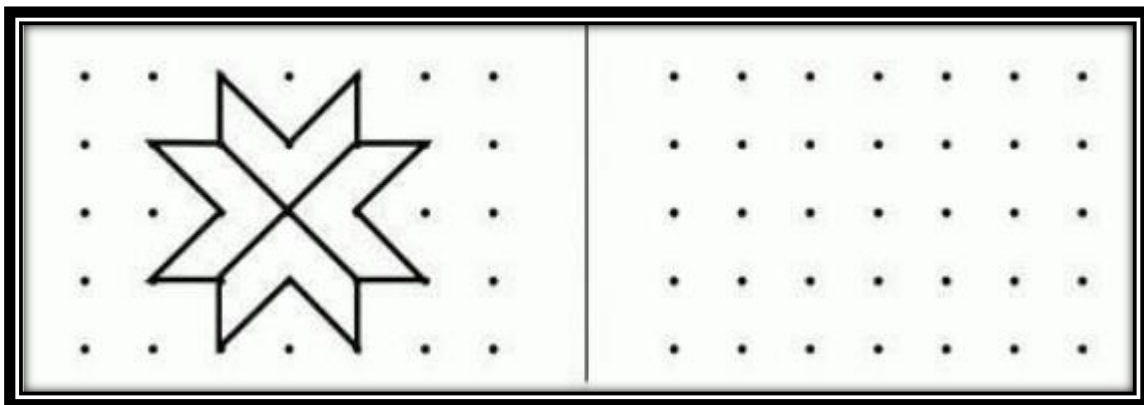
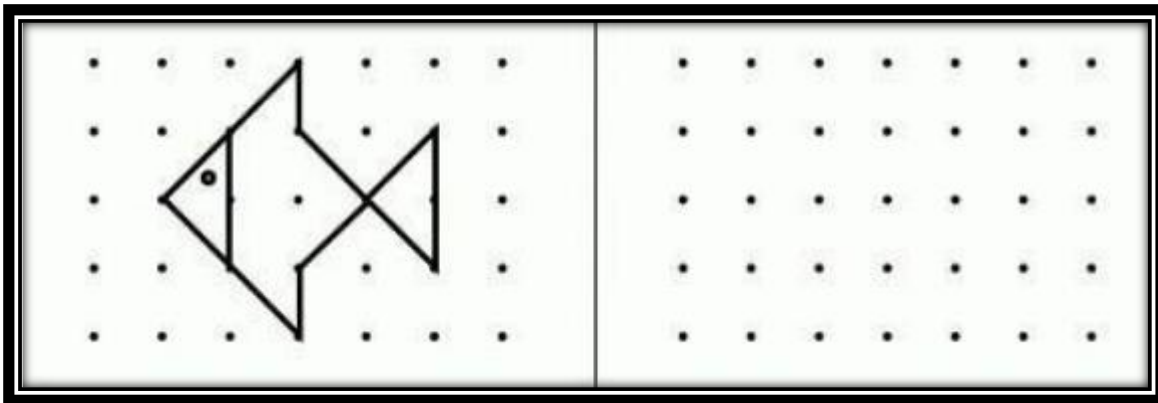
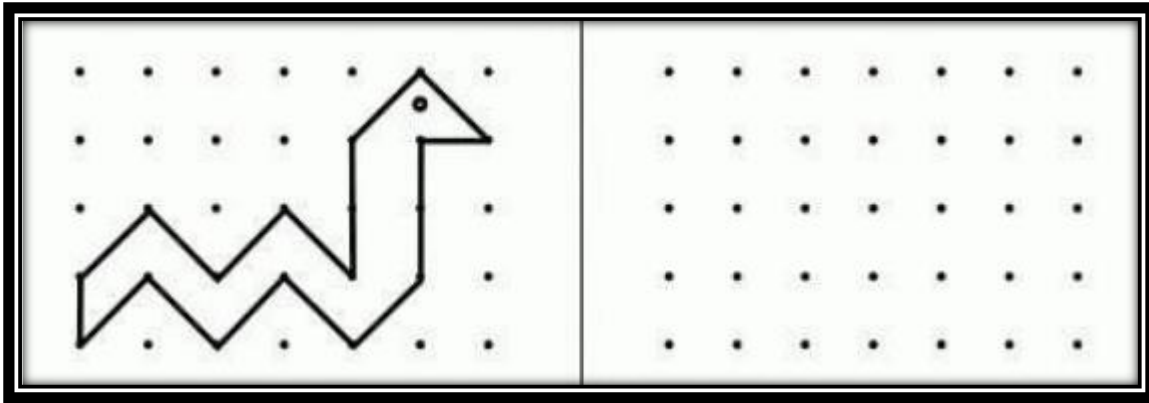

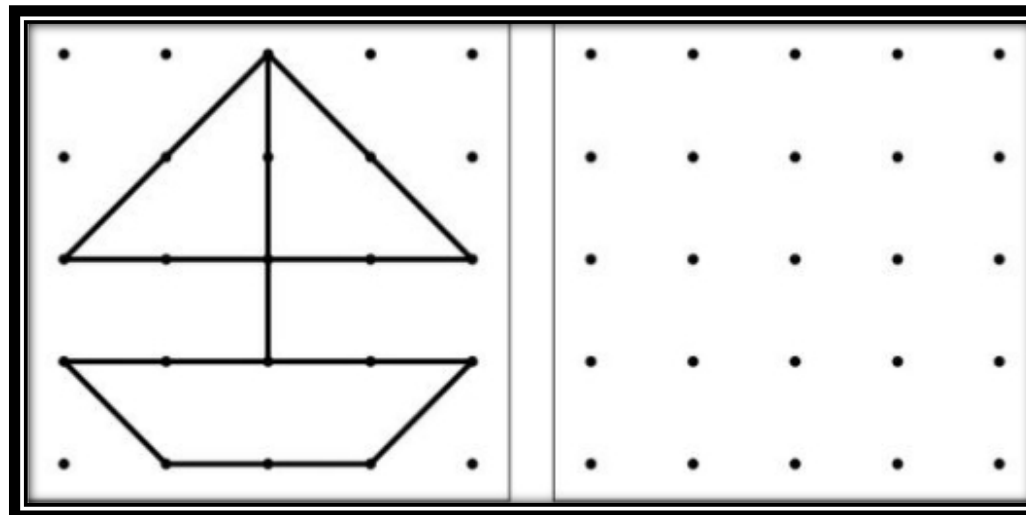
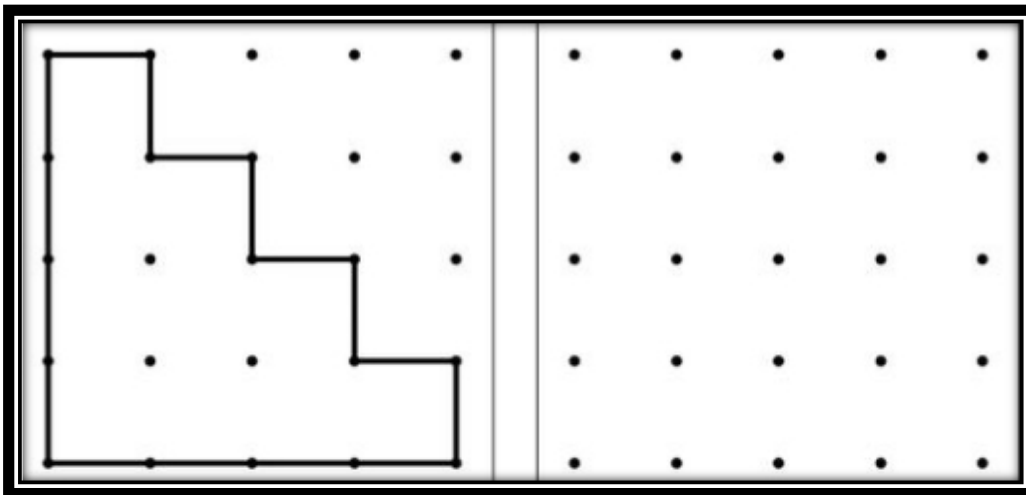
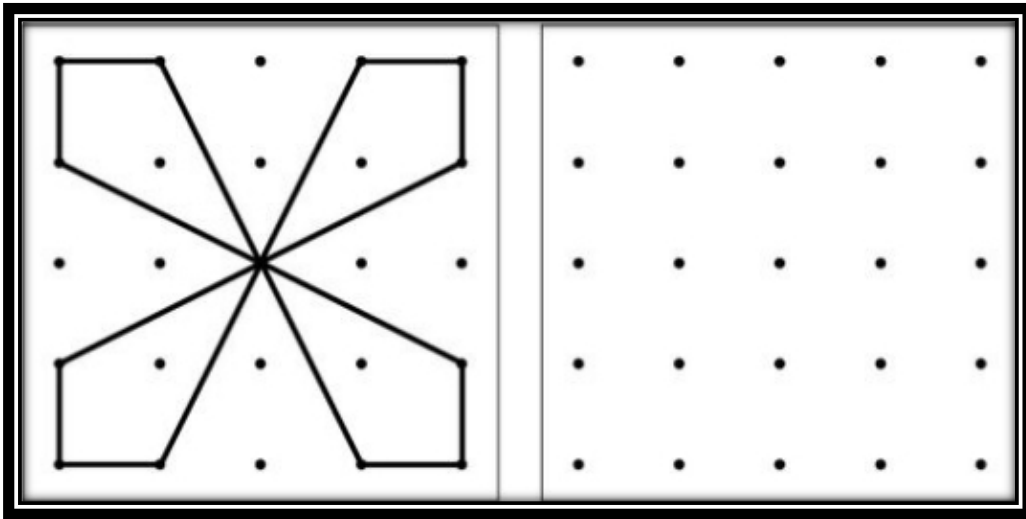

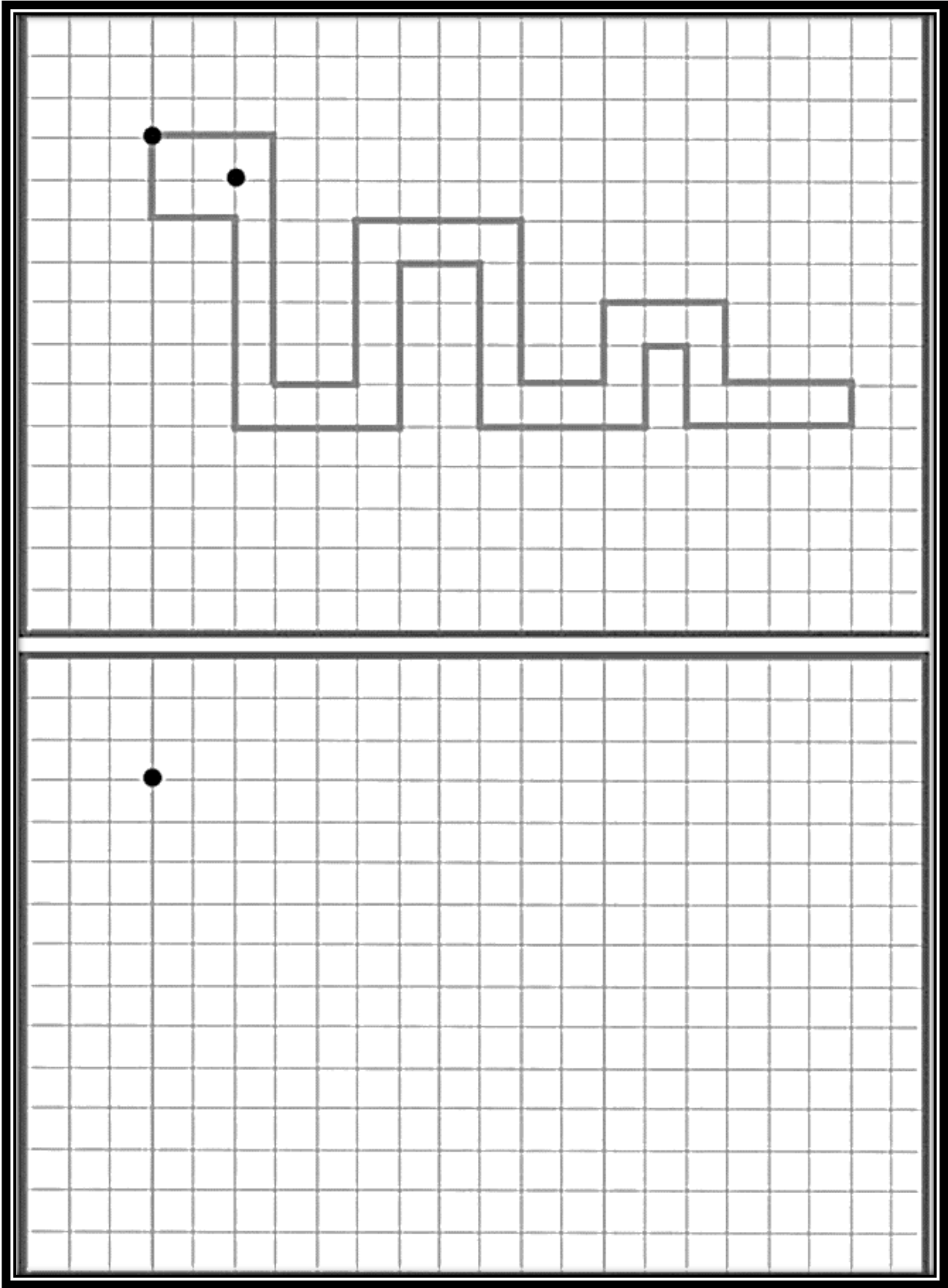

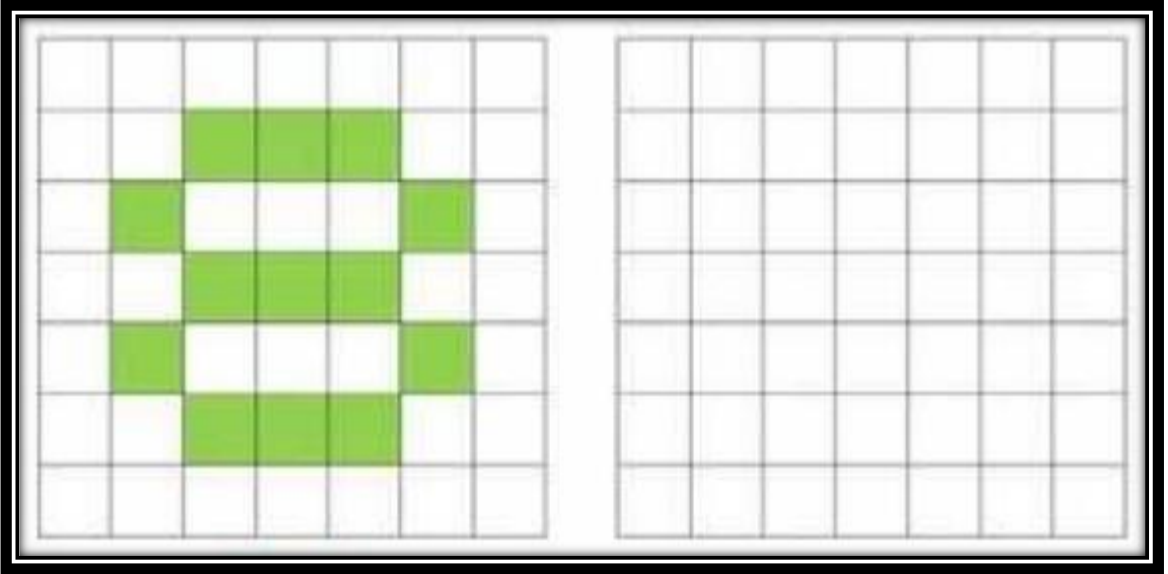
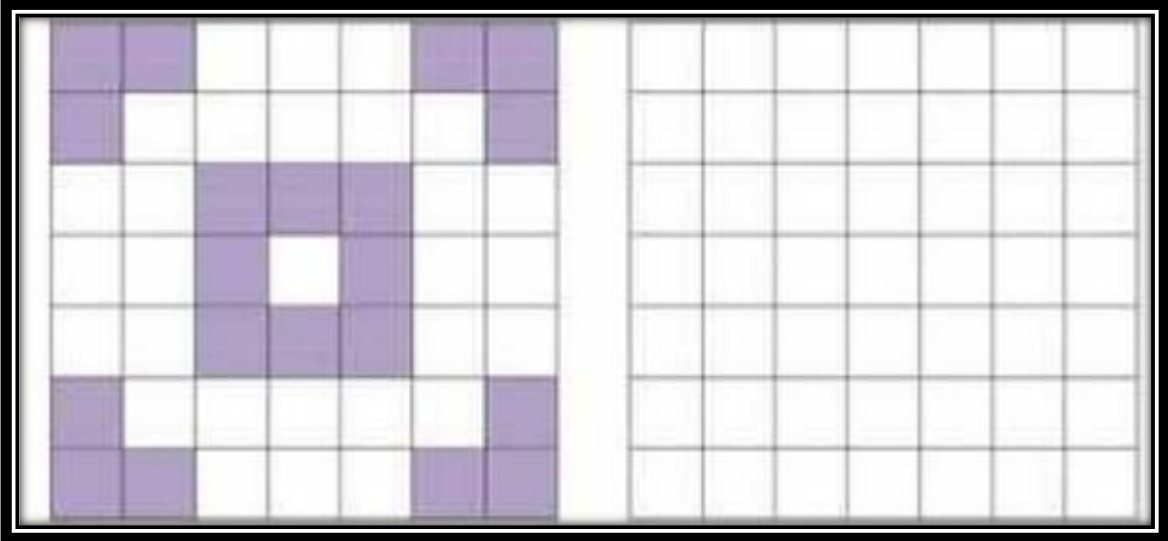

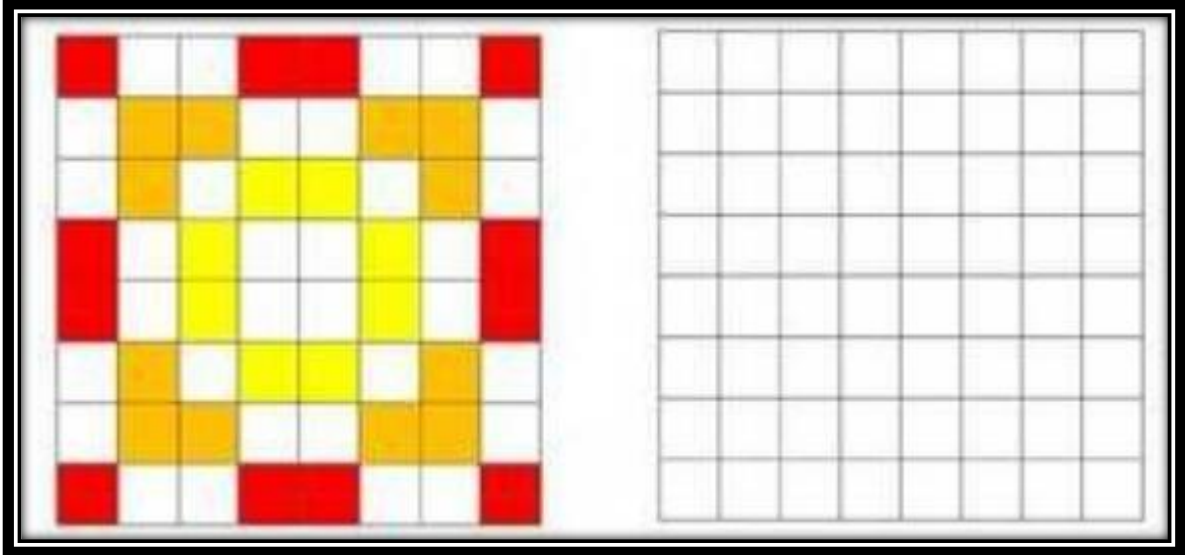
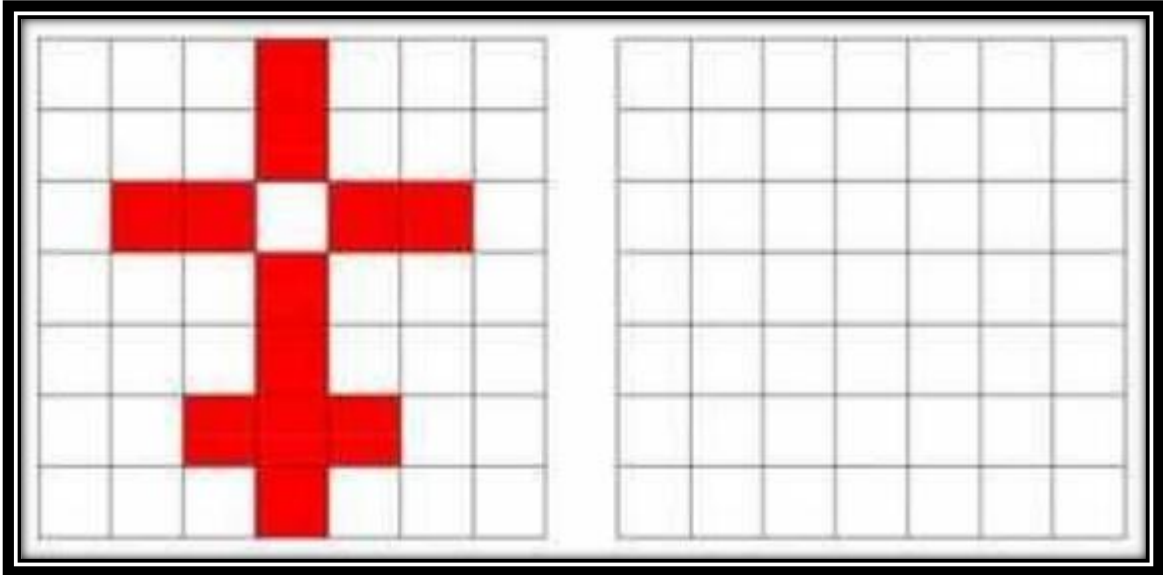

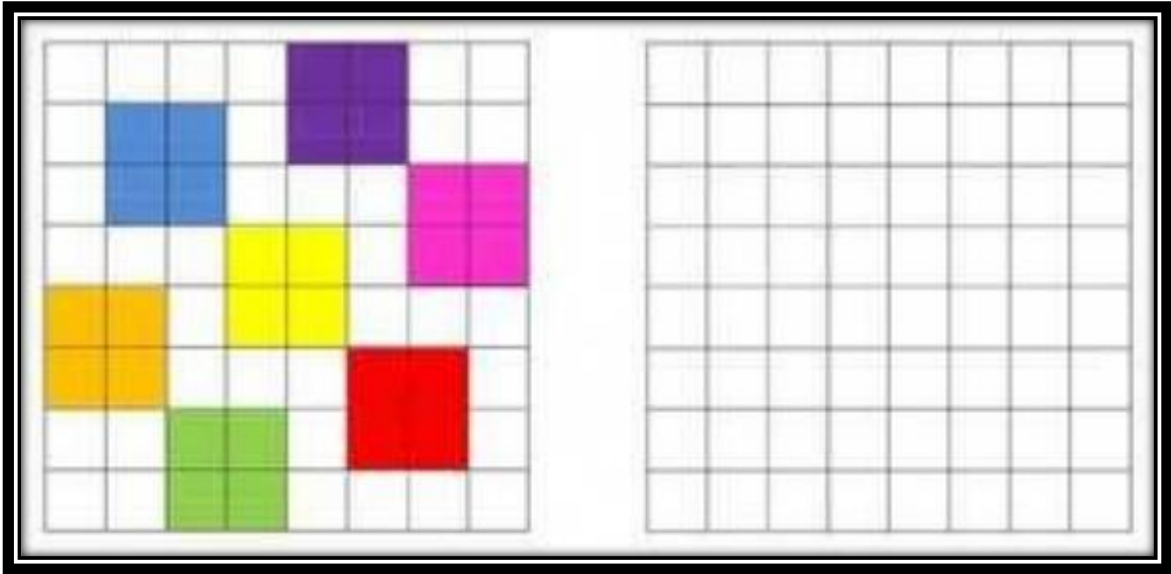
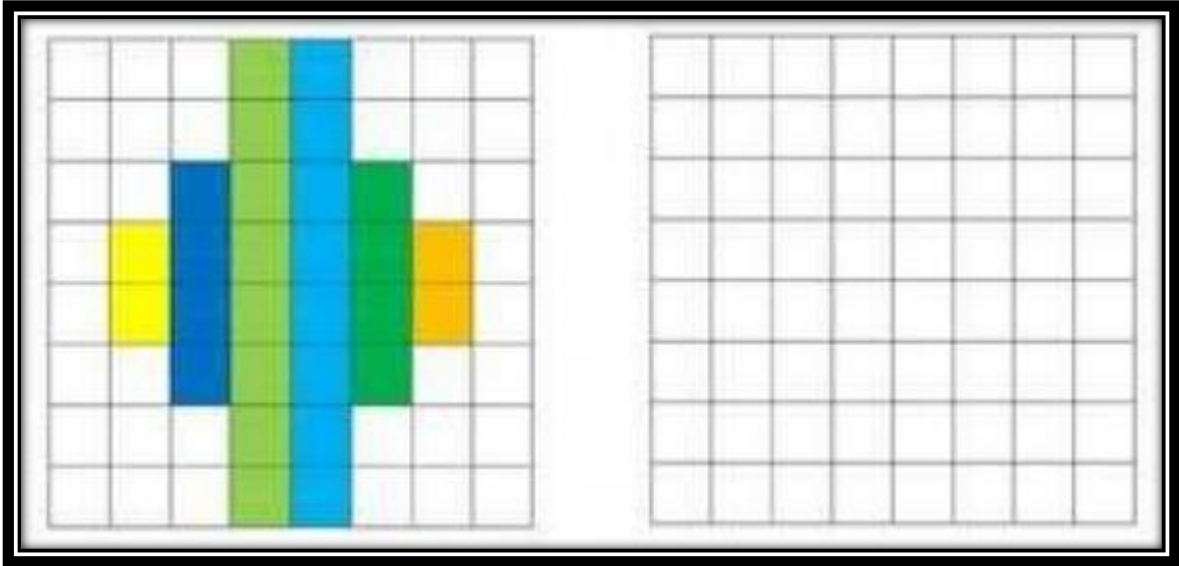



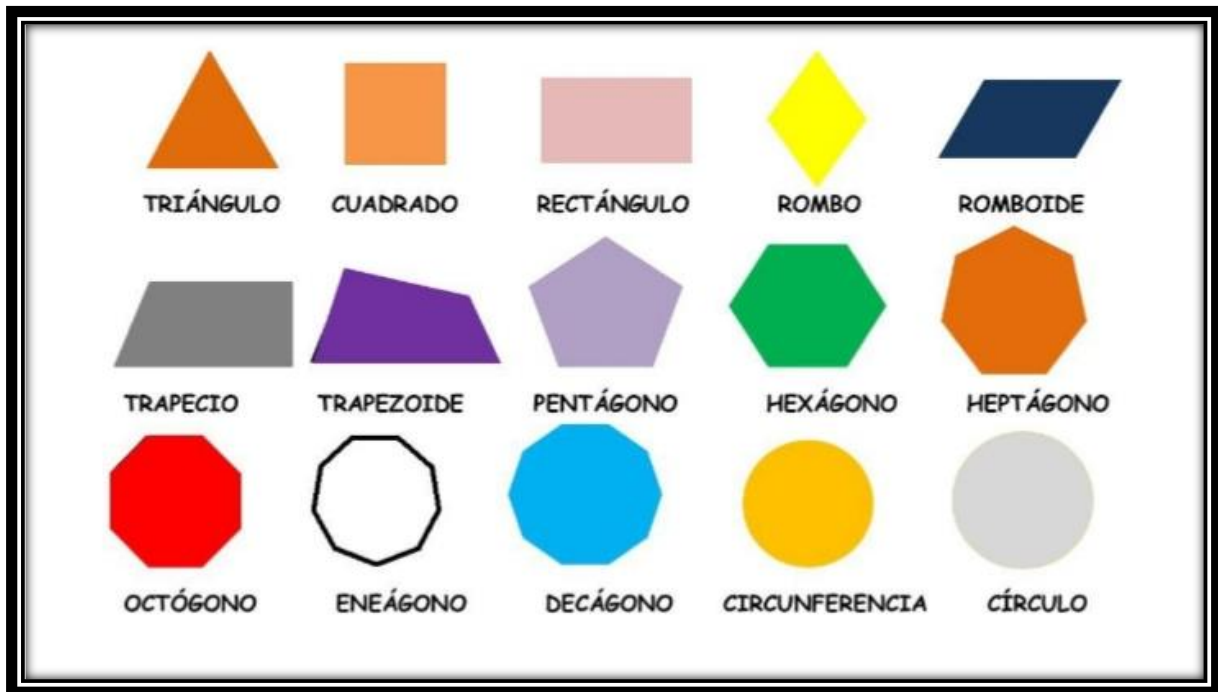





Figuras geométricas









¡A jugar!

Búsqueda del tesoro





¡A BUSCAR!

1	UN VASO		<input type="checkbox"/>
2	UN DADO		<input type="checkbox"/>
3	UNA FLOR		<input type="checkbox"/>
4	UNA OJOTA		<input type="checkbox"/>
5	UN PAR DE MEDIAS		<input type="checkbox"/>
6	UNA COSA REDONDA		<input type="checkbox"/>
7	UNA COLITA DE PELO		<input type="checkbox"/>

¡A BUSCAR!

1	UNA FLOR		<input type="checkbox"/>
2	UN PEINE		<input type="checkbox"/>
3	UN BALDE		<input type="checkbox"/>
4	UN ANILLO		<input type="checkbox"/>
5	UNA LAPICERA		<input type="checkbox"/>
6	UN PANTALÓN CORTO		<input type="checkbox"/>
7	UNA COSA DE COLOR BLANCO		<input type="checkbox"/>

¡A BUSCAR!

1	UN MATE		<input type="checkbox"/>
2	UN DADO		<input type="checkbox"/>
3	UNA OJOTA		<input type="checkbox"/>
4	UNA BOTELLA		<input type="checkbox"/>
5	ALGO DE COLOR VERDE		<input type="checkbox"/>
6	UN PEDAZO DE PAPEL		<input type="checkbox"/>
7	ALGO DE FORMA CUADRADA		<input type="checkbox"/>

Bingo







Nadia Rückauf
Autora

Prof. Daniel González
Prólogo y compilación

ESTIMULACIÓN COGNITIVA

Cuadernillo de Actividades I

OTROS TÍTULOS DISPONIBLES DE LA COLECCIÓN

CUADERNILLOS PARA ACOMPAÑAR

Estimulación Temprana

Estimulación Emocional

Ansiedad y Depresión

Adultos Mayores



Centro
PsicoSocial
Argentino



@centropsicosocialargentino



11 4970-5299



Centro Psicosocial Argentino Cpsa

Esta es una edición especial del Centro PsicoSocial Argentino